



ilkokul1.com

ÇİZGİ ÇALIŞMALAR KİTABI



ÜCRETSİZ VE
ÖZGÜN ETKİNLİKLER

Bu kitap  ilkokul1.com tarafından hazırlanmış ve ücretsiz olarak paylaşılmıştır.

Kaynak gösterilse dahi başka platformlarda paylaşılması, ekonomik çıkar maksadıyla çoğaltılmasına veya satılmasına izin vermiyoruz!

İlginize teşekkür ederiz.

 ilkokul1.com

Emrah & Elvan PEKŞEN



Pekşen Yayınları
1. Sınıf Kolay Okutan Set
Yalnızca 40 TL

Detaylar ve Sipariş İçin:
www.peksen yayinlari.com

ÇİZGİ ÇALIŞMALARI



Nokta Birleştir

 ilkokul1.com



Boya

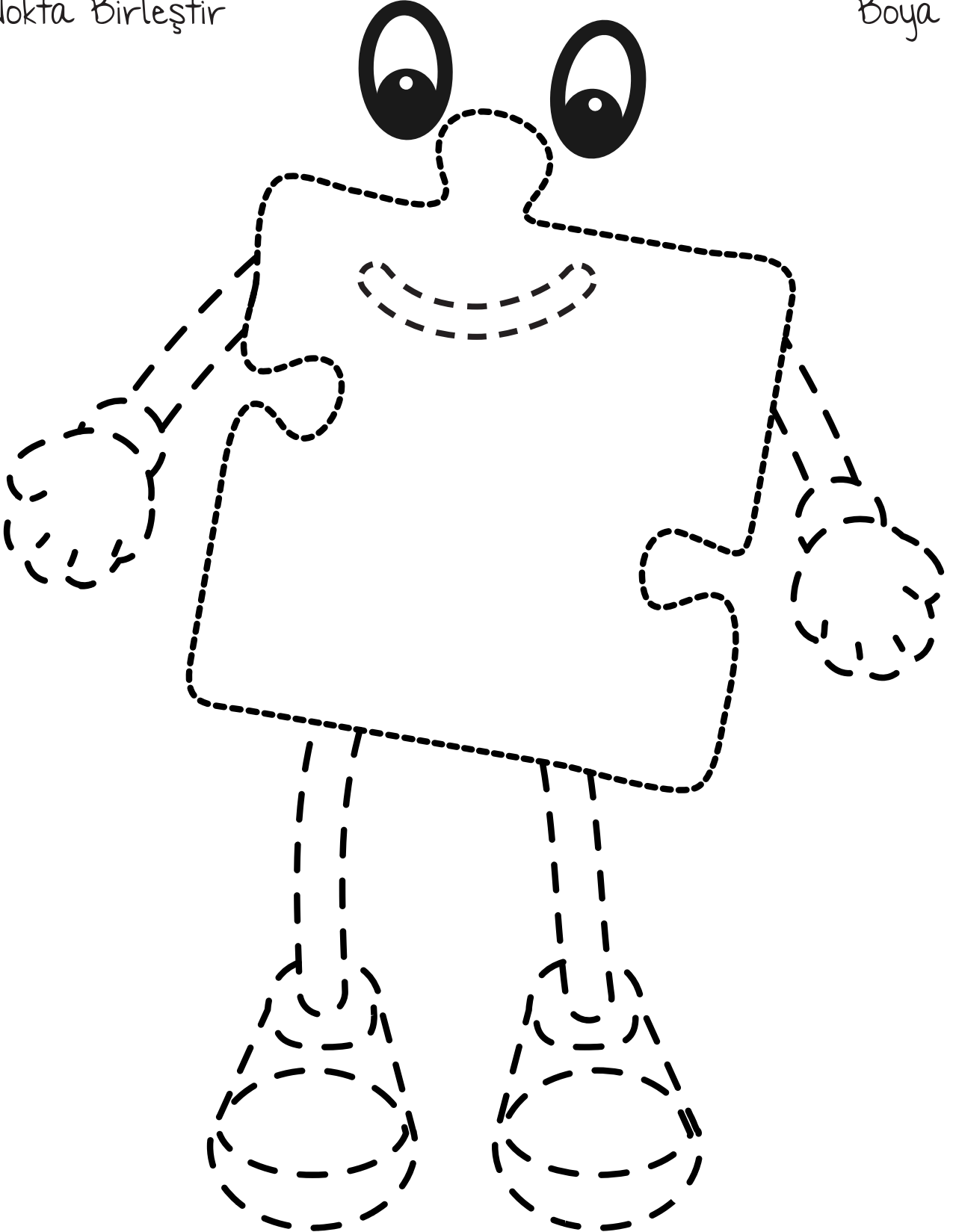

ÇİZGİ ÇALIŞMALARI



Nokta Birleştir

 ilkokul1.com



Boya

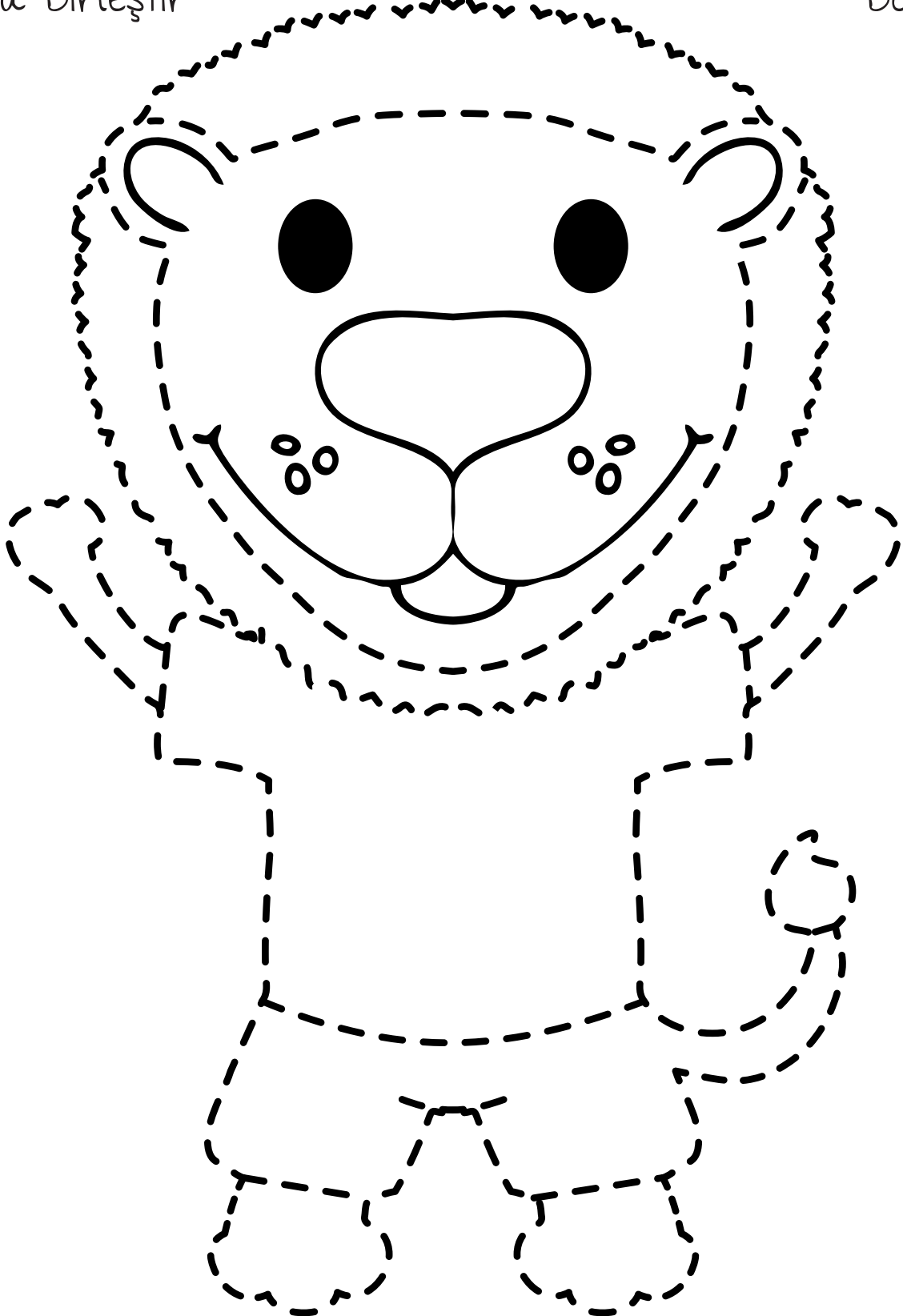

ÇİZGİ ÇALIŞMALARI



Nokta Birleştir

 ilkokul1.com



Boya

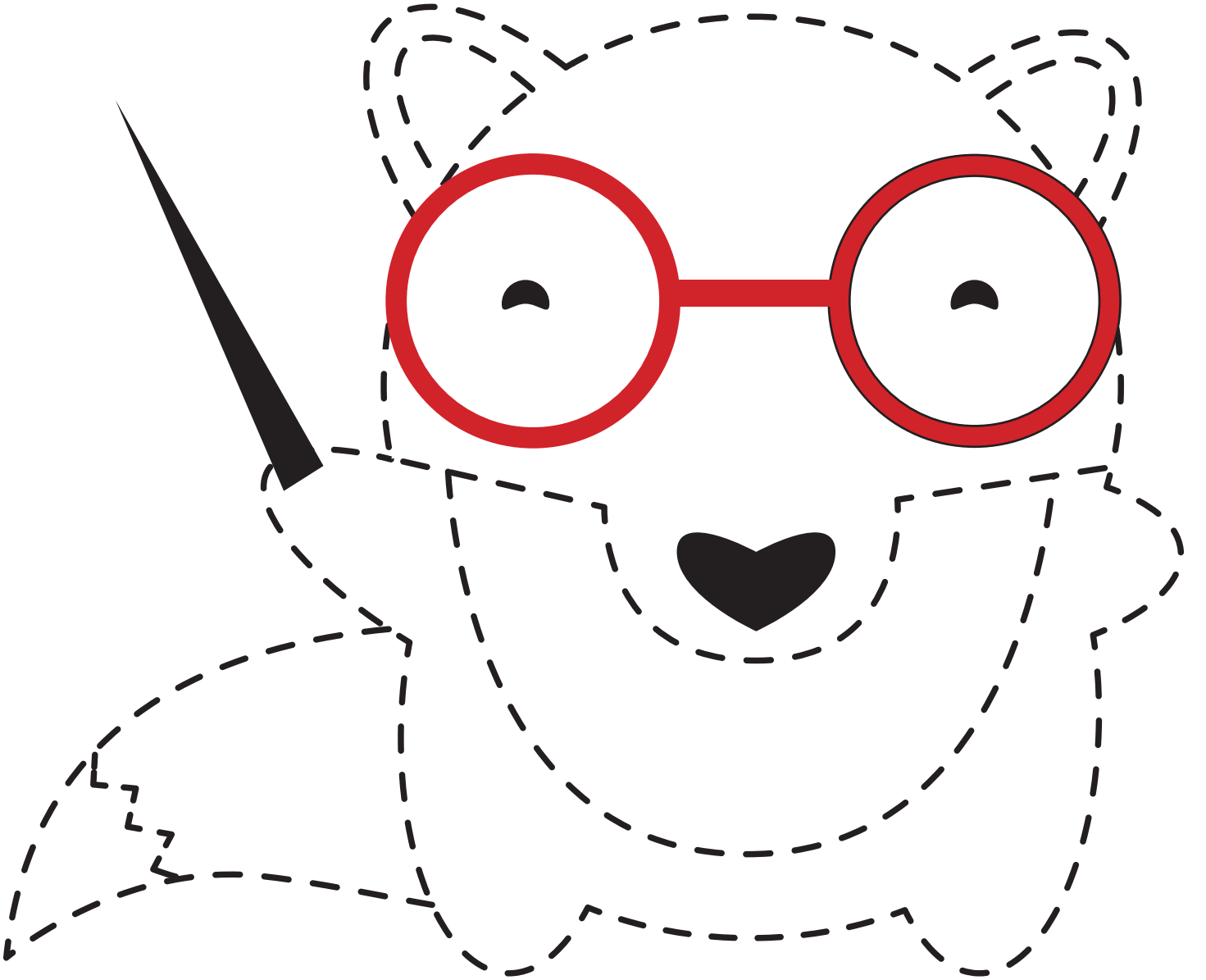

ÇİZGİ ÇALIŞMALARI



Nokta Birleştir

ilkokul1.com



Boya

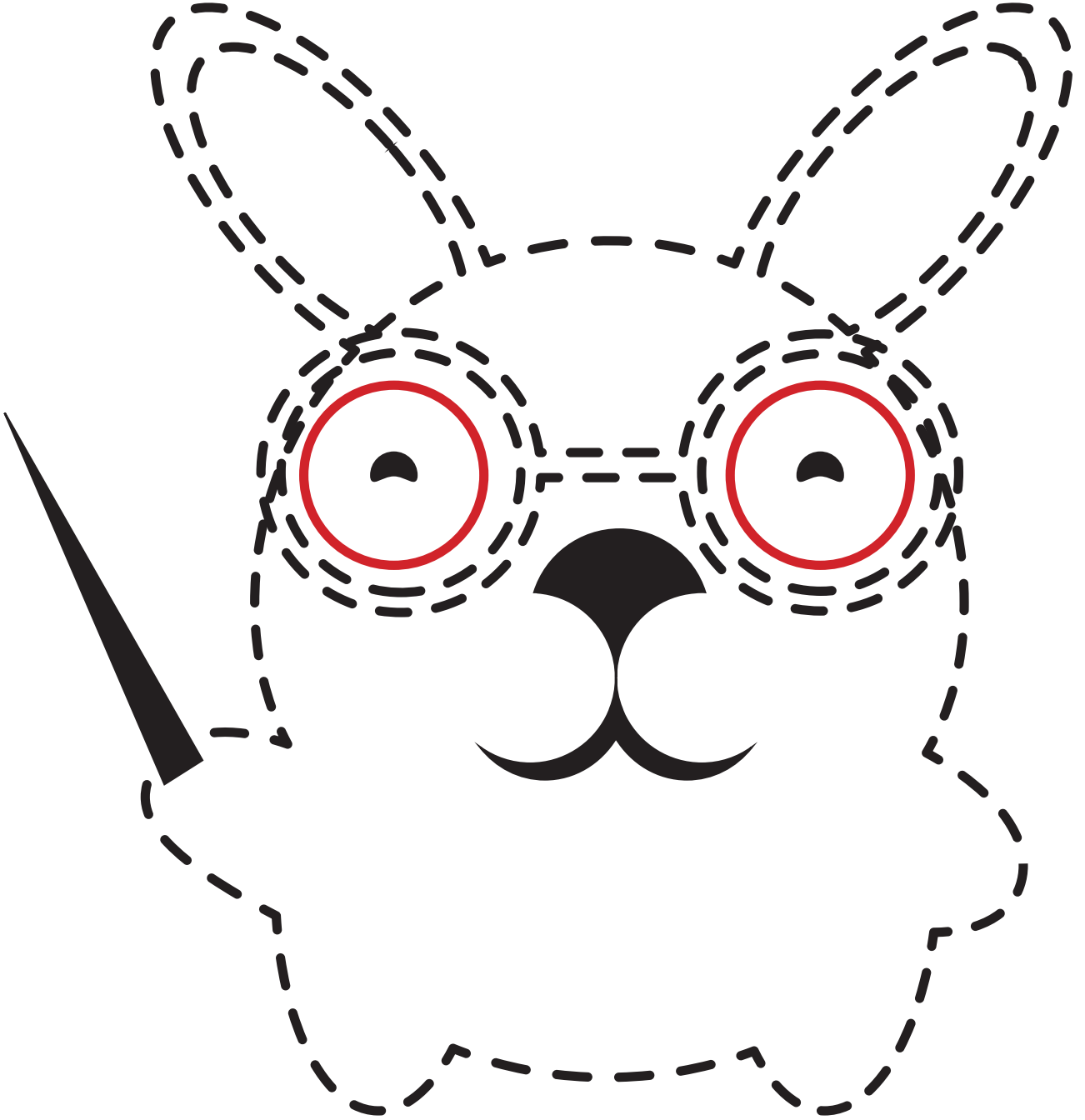

ÇİZGİ ÇALIŞMALARI



Nokta Birleştir

 ilkokul1.com



Boya

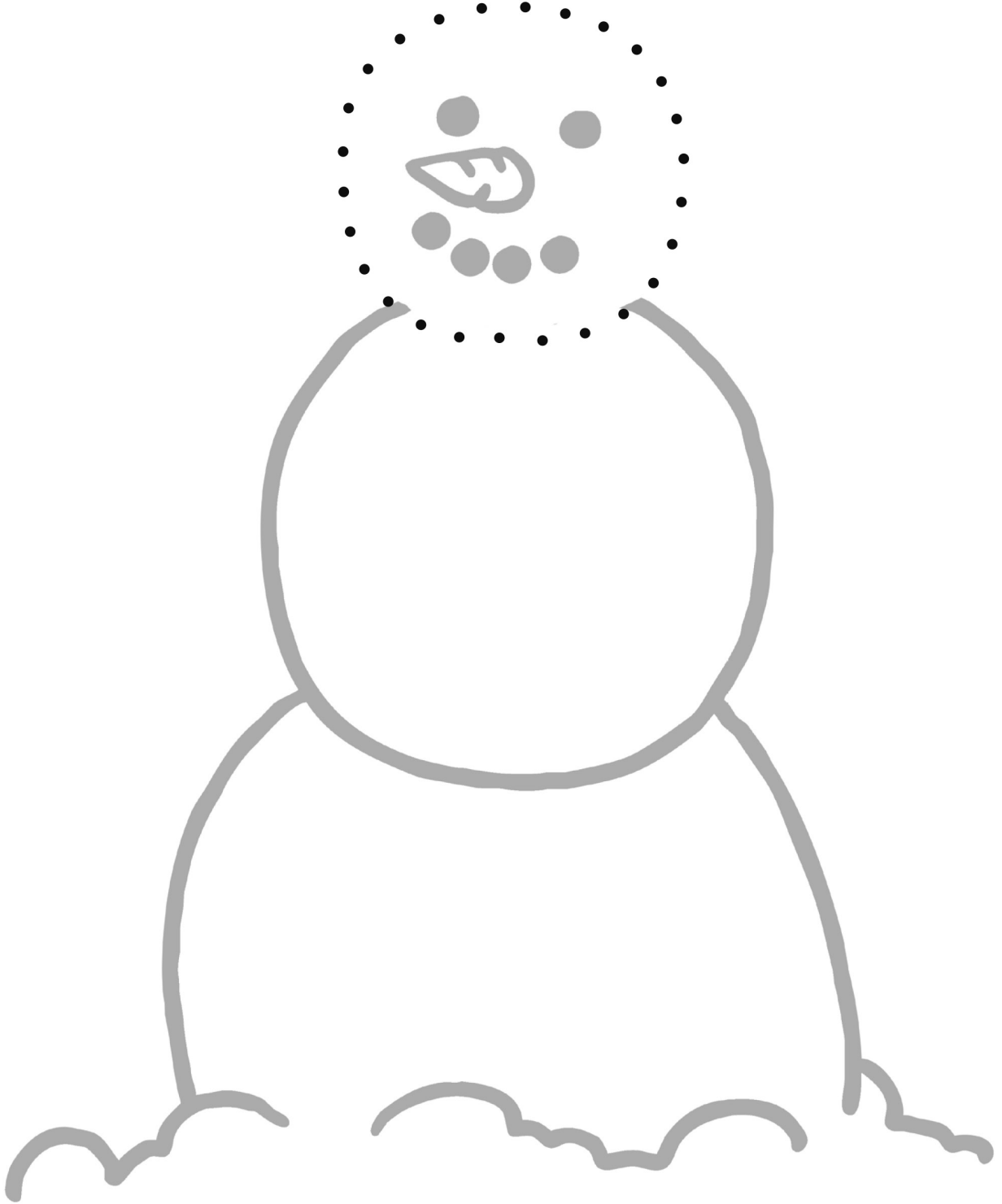



Nokta Birleřtir

ilkokul1.com



Boya

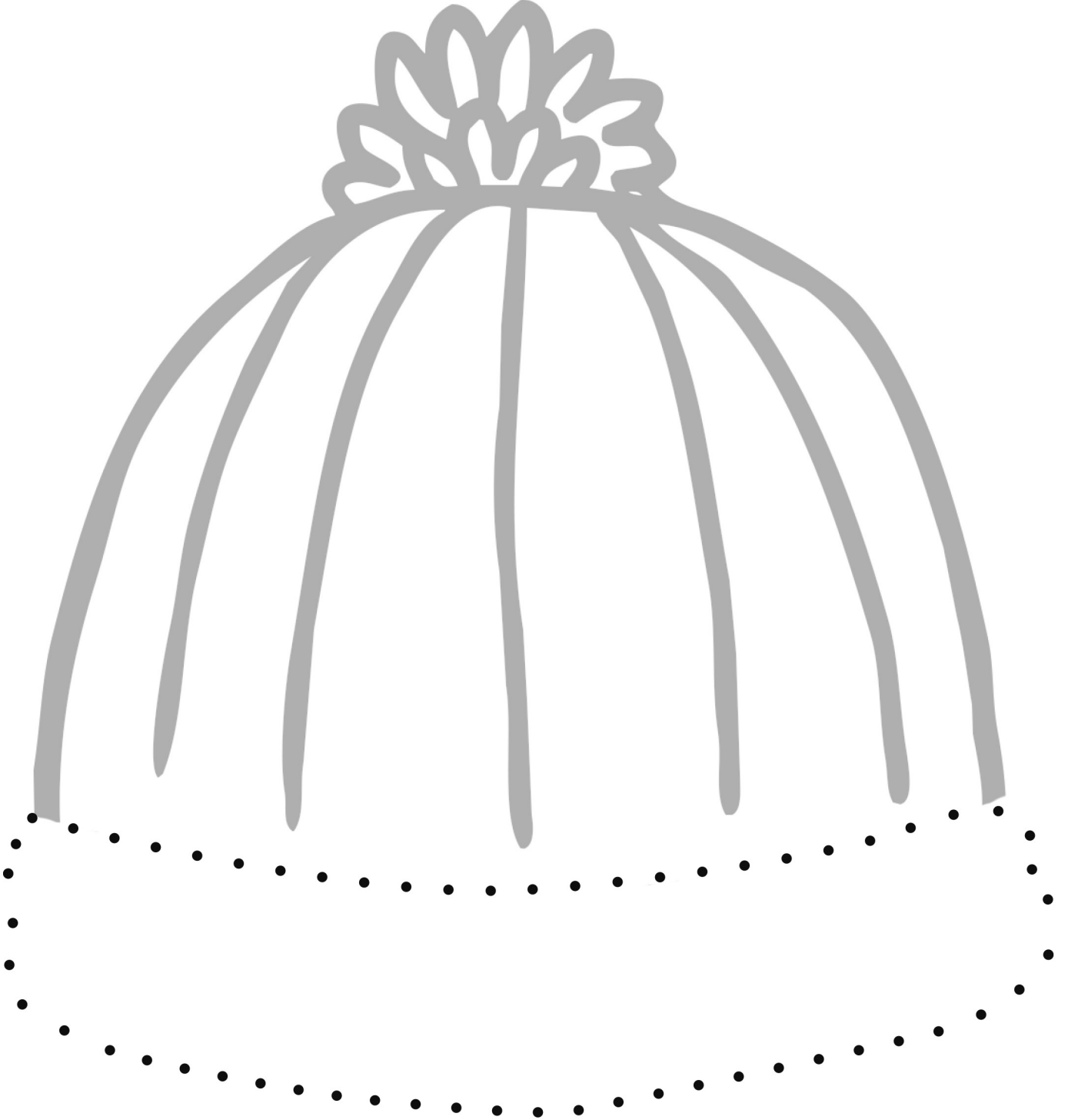

ÇİZGİ ÇALIŞMALARI



Nokta Birleştir

 ilkokul1.com



Boya

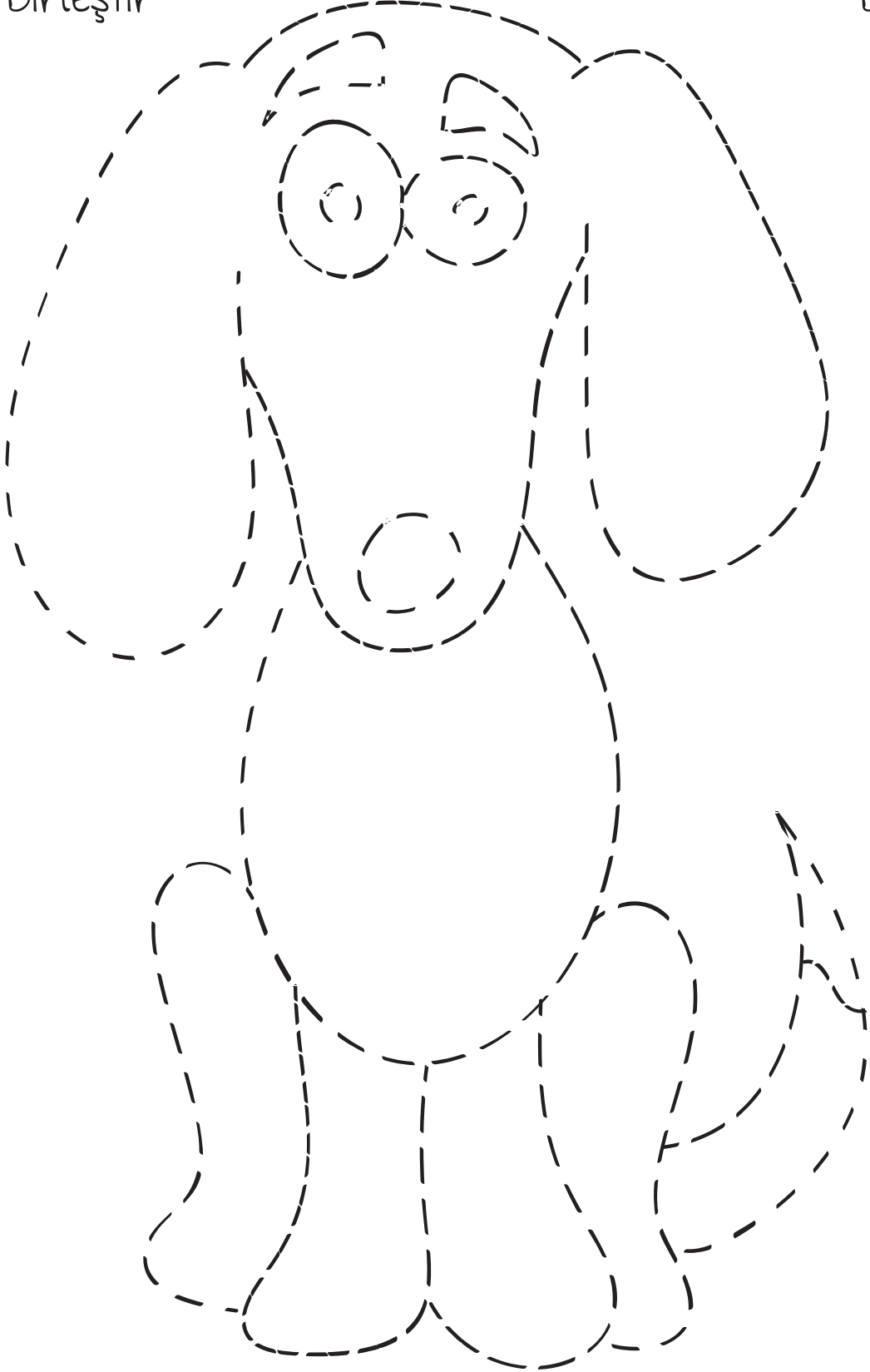



Nokta Birleřtir

 ilkkokul1.com



Boya

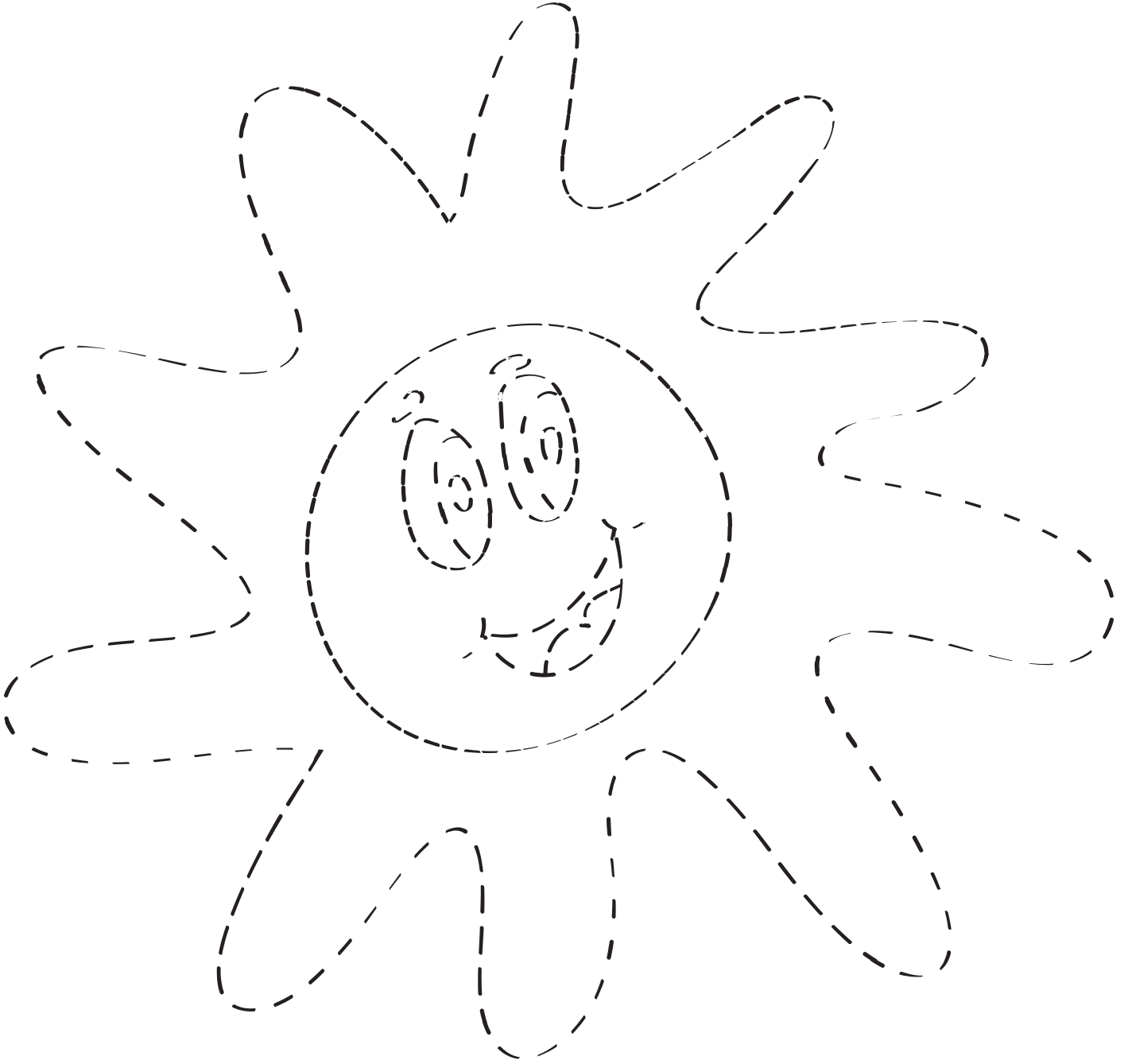

ÇİZGİ ÇALIŞMALARI



Nokta Birleştir

ilkokul1.com



Boya

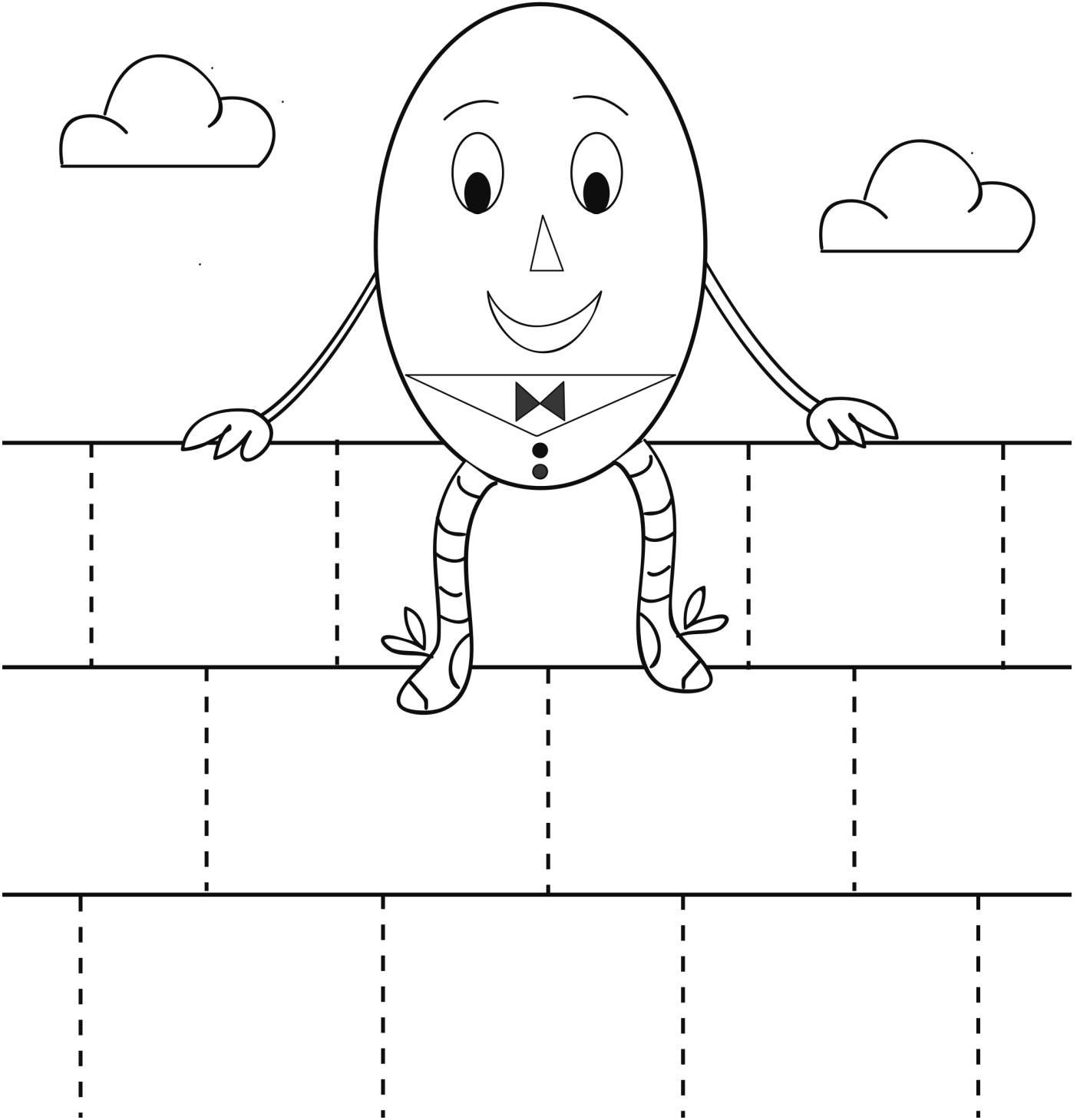

ÇİZGİ ÇALIŞMALARI



Nokta Birleştir

 ilkokul1.com



Boya

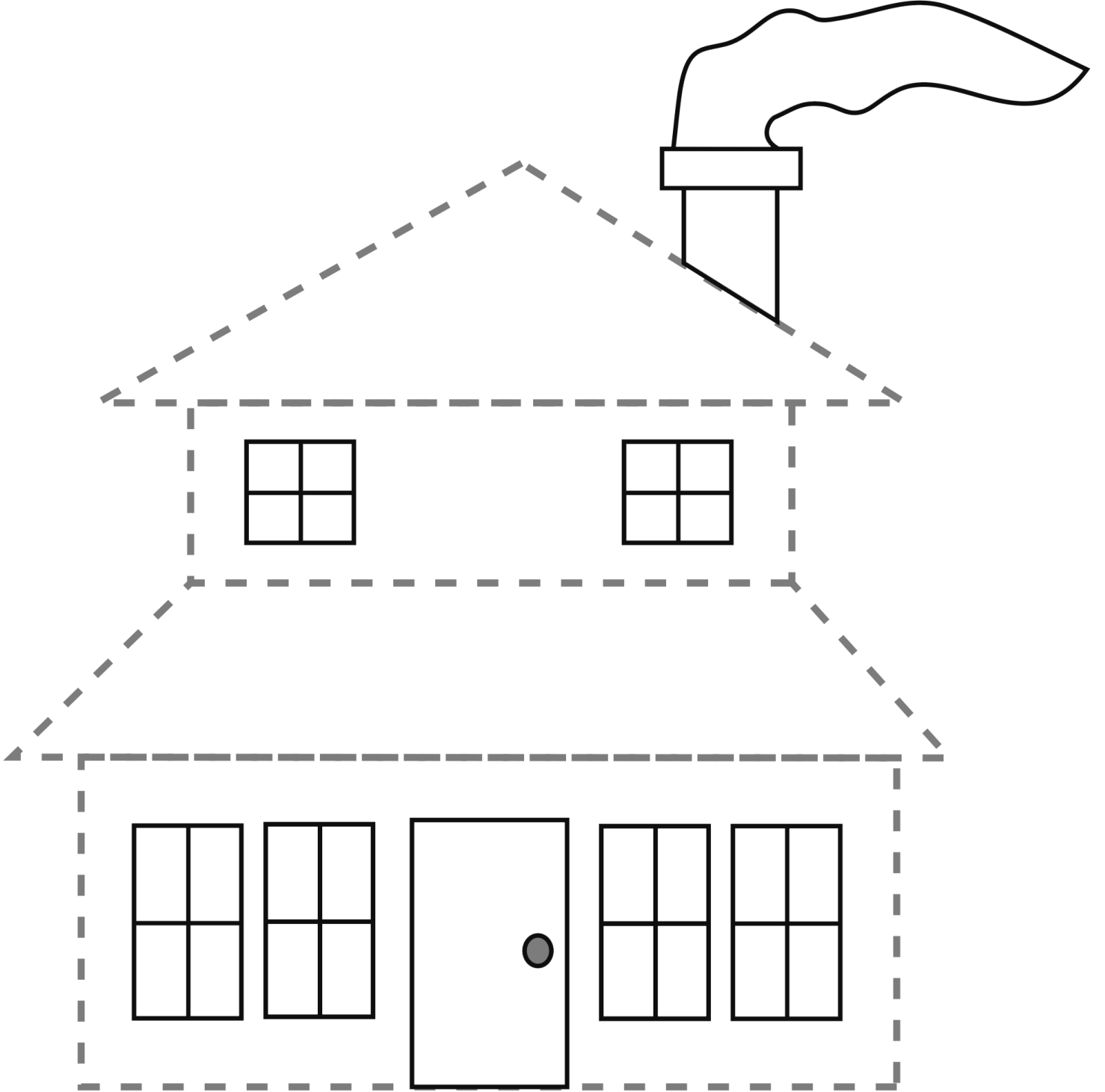

ÇİZGİ ÇALIŞMALARI



Nokta Birleştir



Boya

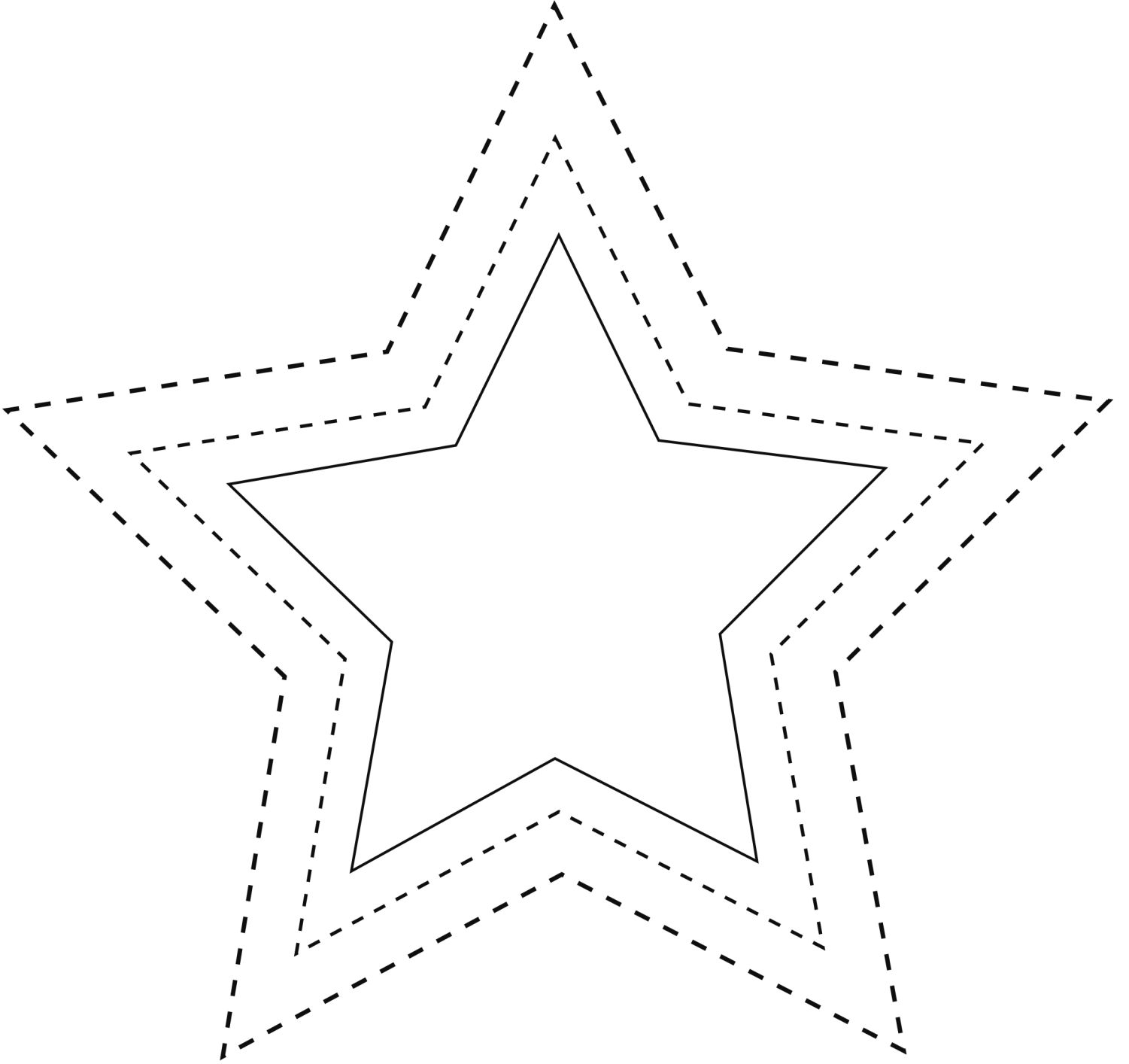

ÇİZGİ ÇALIŞMALARI



Nokta Birleştir

 ilkokul1.com



Boya

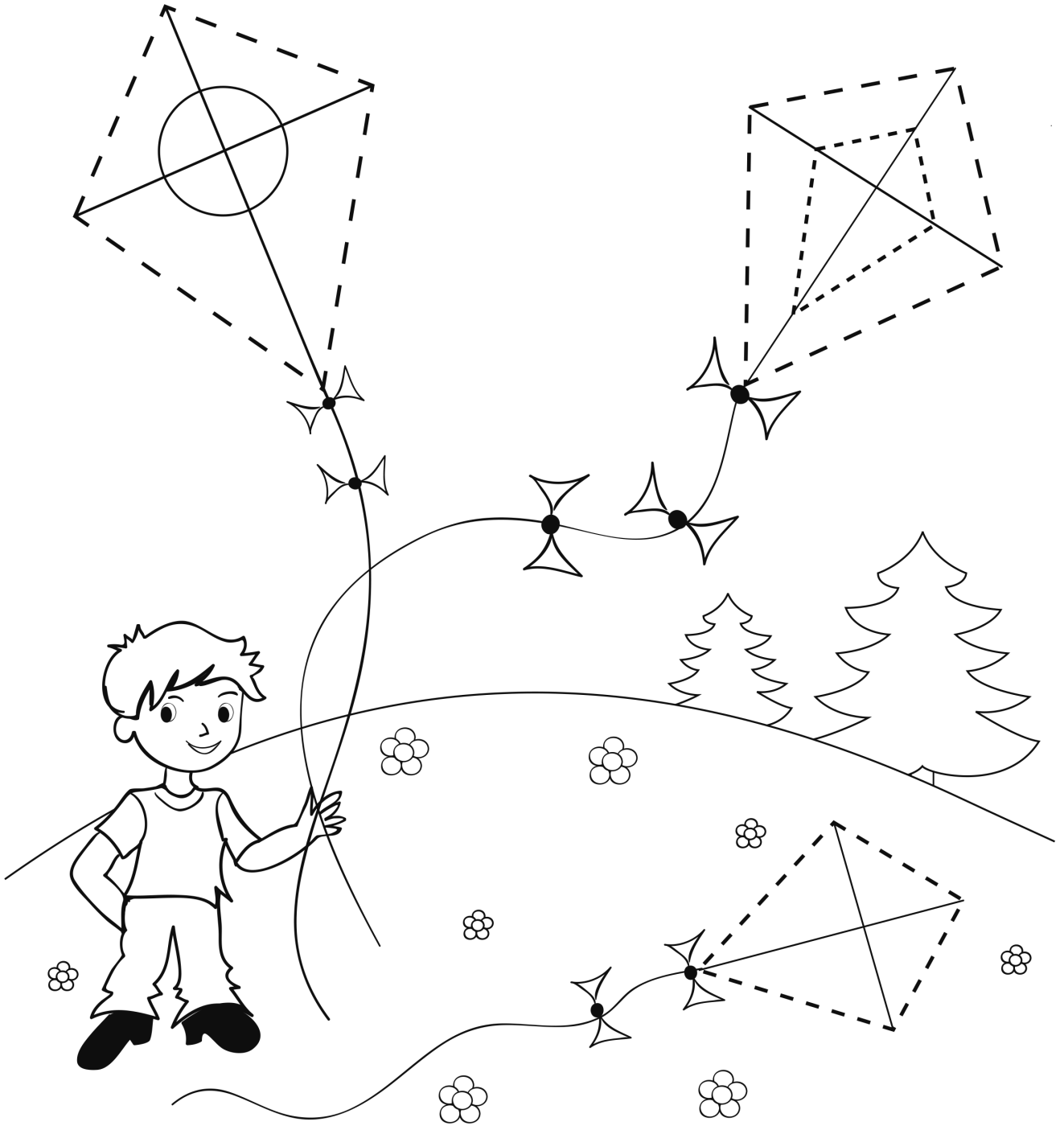

ÇİZGİ ÇALIŞMALARI



Nokta Birleştir

ilkokul1.com

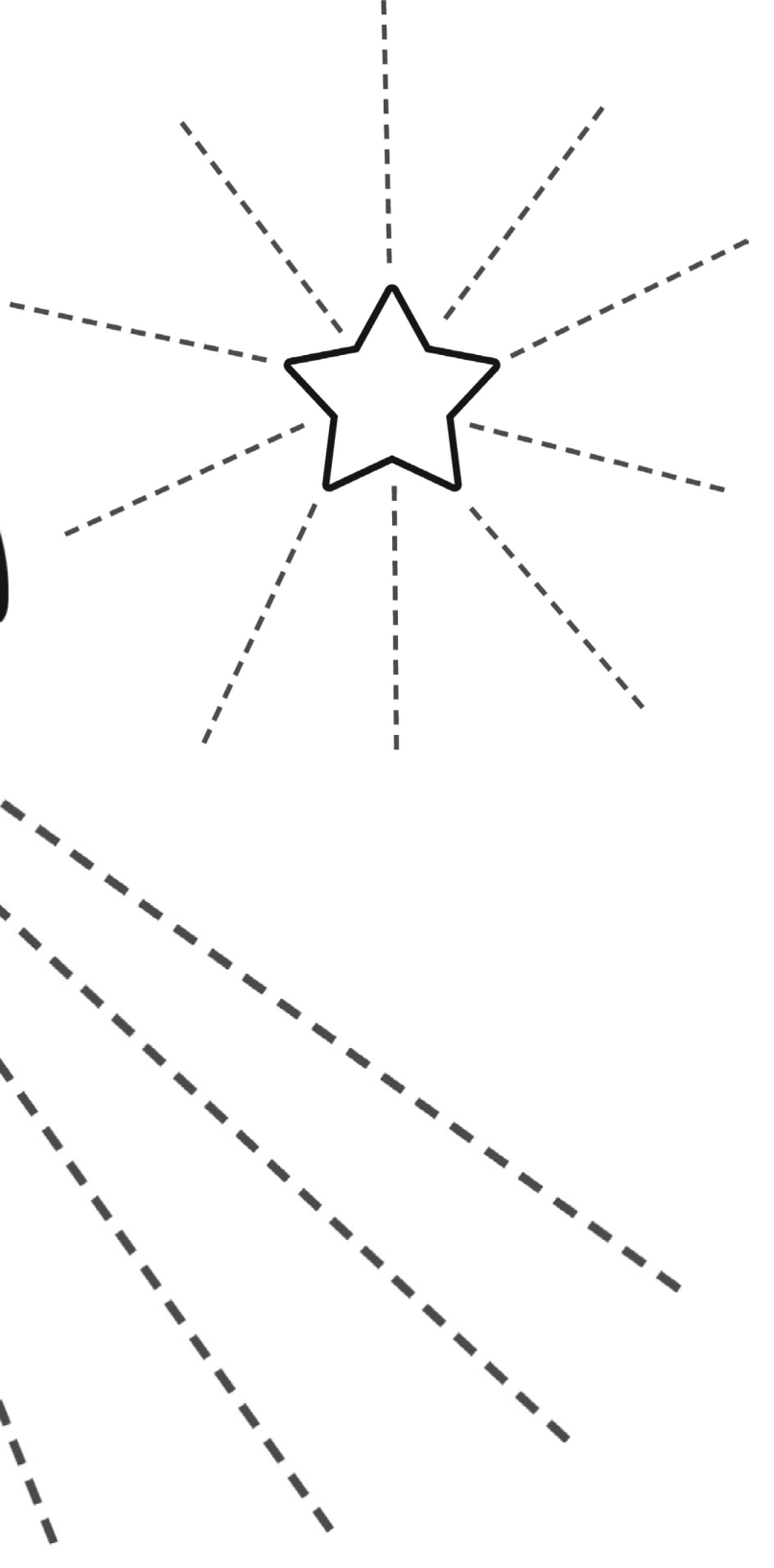
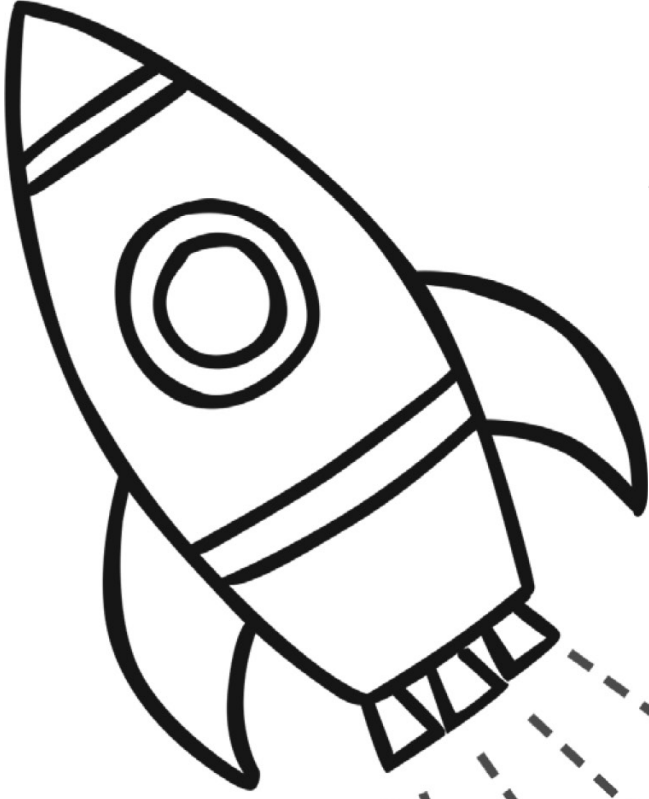

ÇİZGİ ÇALIŞMALARI



Nokta Birleştir

 ilkokul1.com

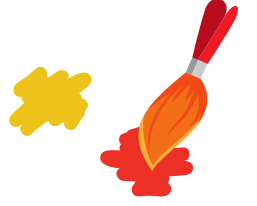

Boya

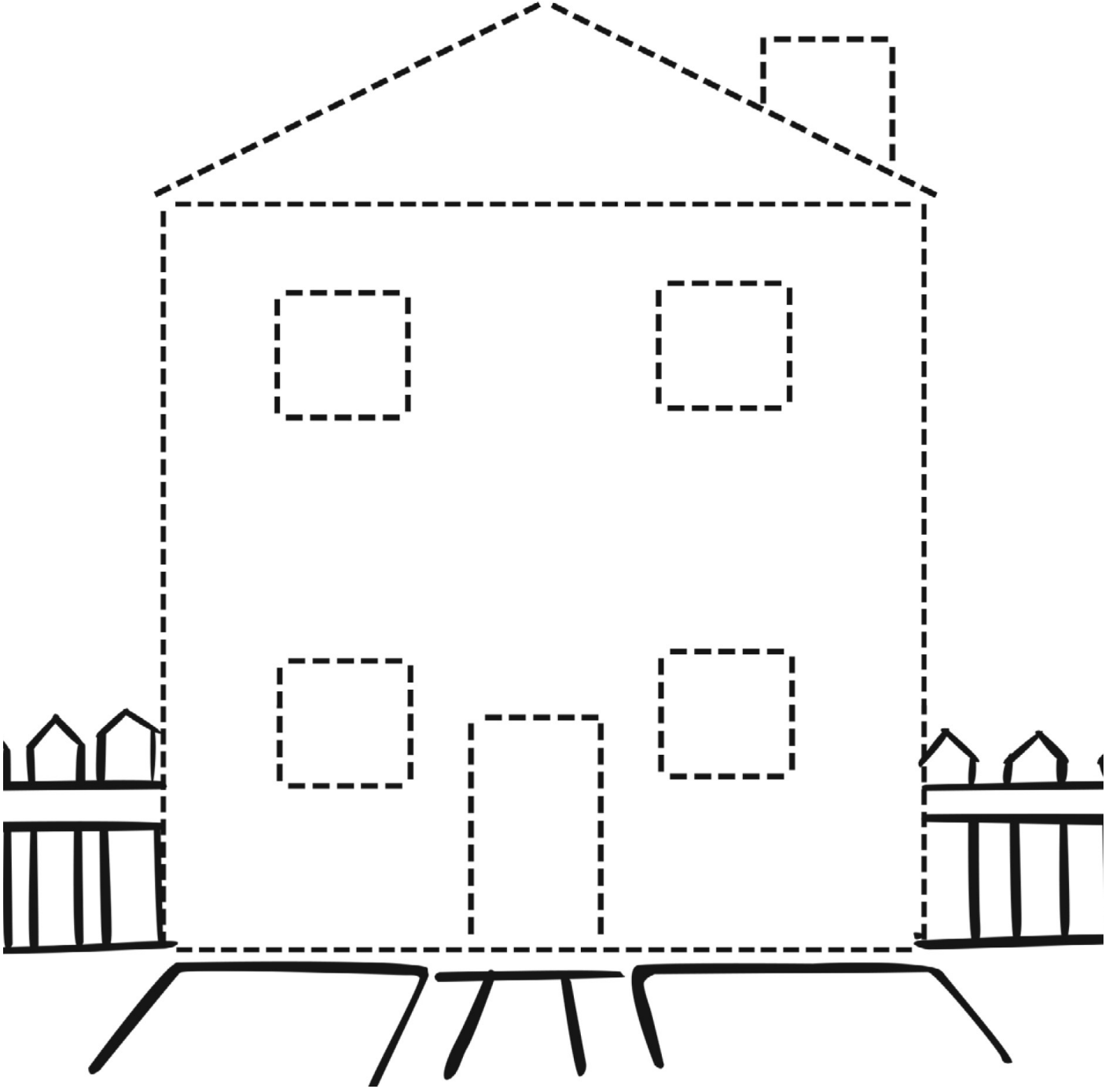

● Aşağıdaki arıları ve kelebekleri noktaları birleştirip çiçeklere ulaştırınız.



● Aşağıdaki noktaları belirtilen yönde birleştirerek çizgiler çizin.

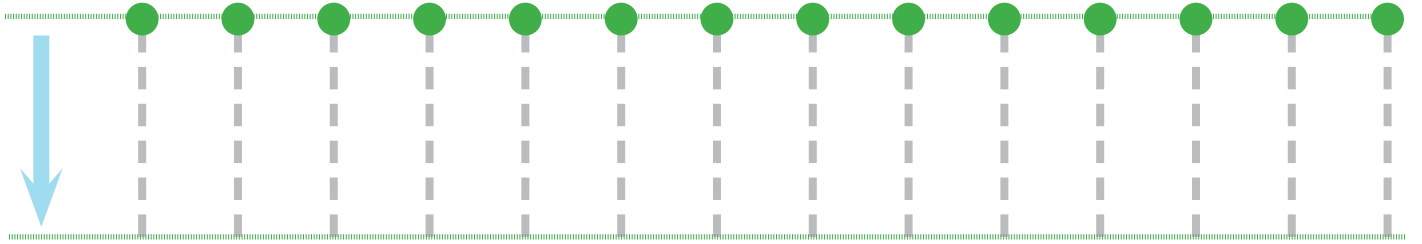
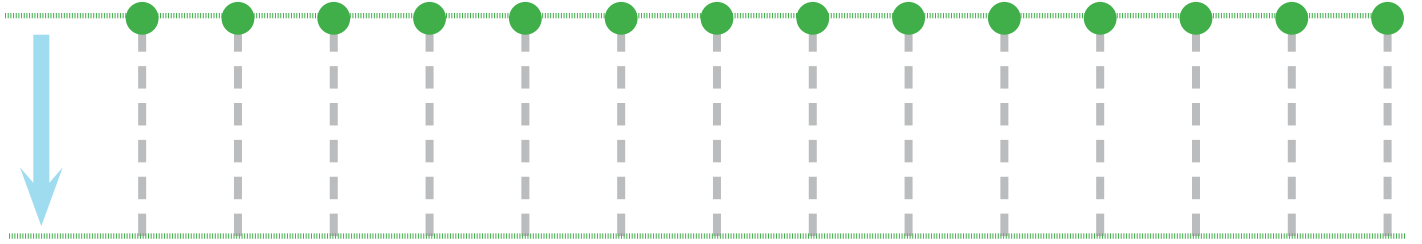
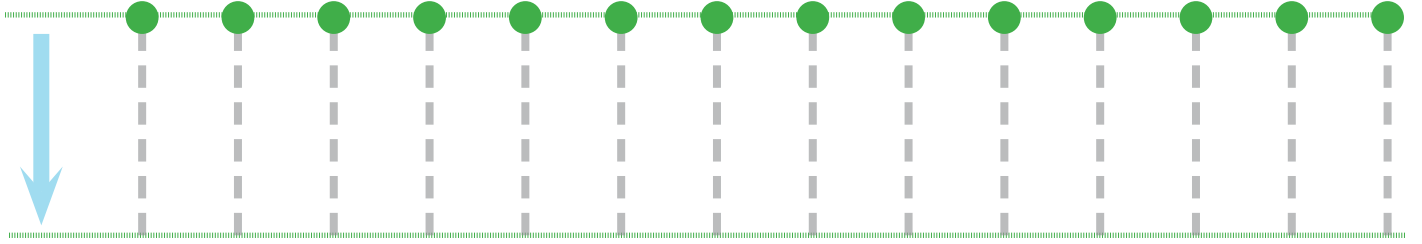
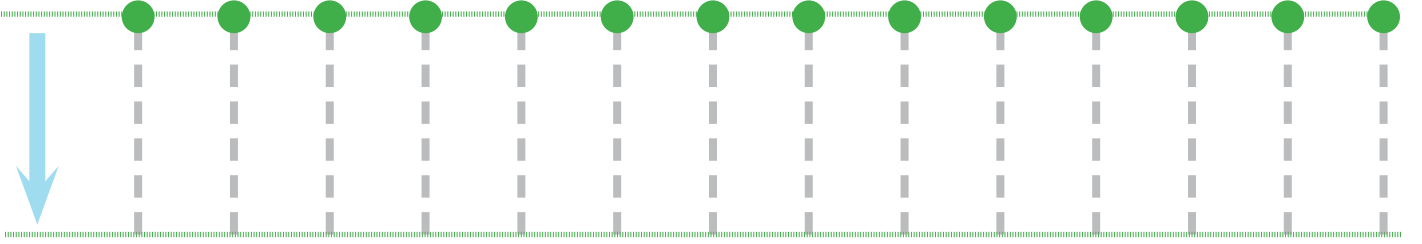

ÇİZGİ ÇALIŞMALARI

- Aşağıdaki noktaları belirtilen yönde birleştirerek çizgiler çiziniz.



Four rows of handwriting practice lines. Each row consists of a solid top line, a dashed middle line, and a solid bottom line. A dashed arrow on the left of each row points downwards, indicating the direction of the stroke.

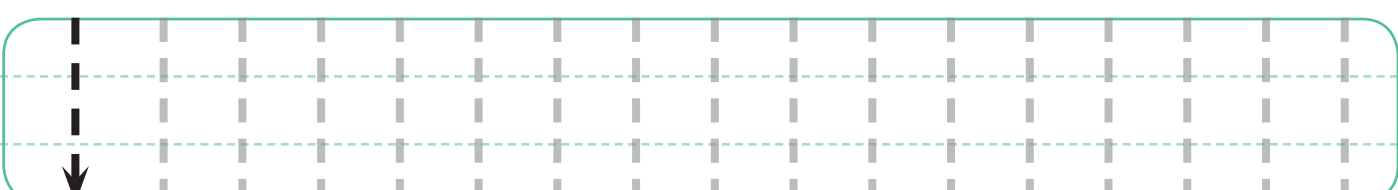
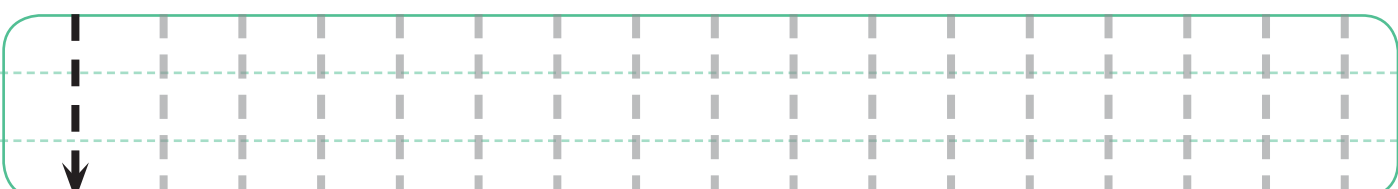
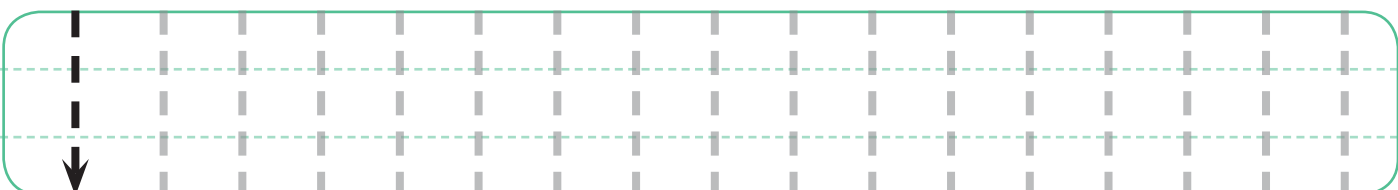
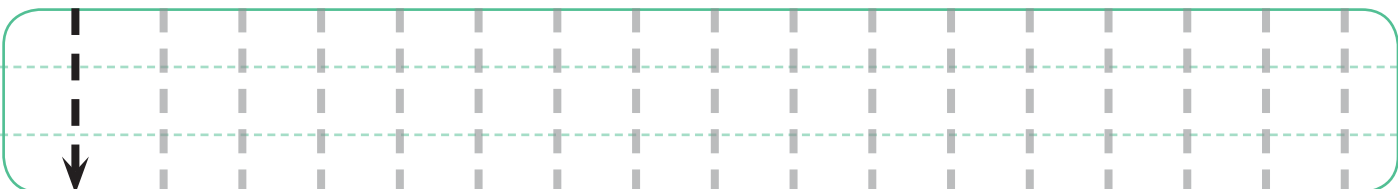
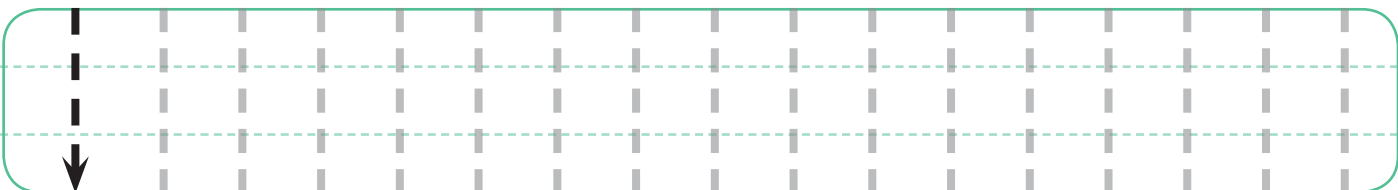
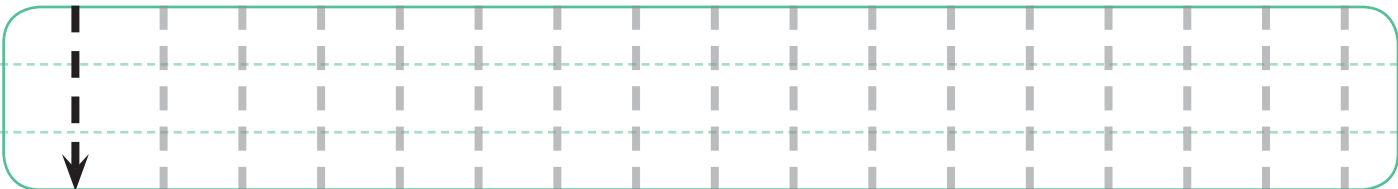
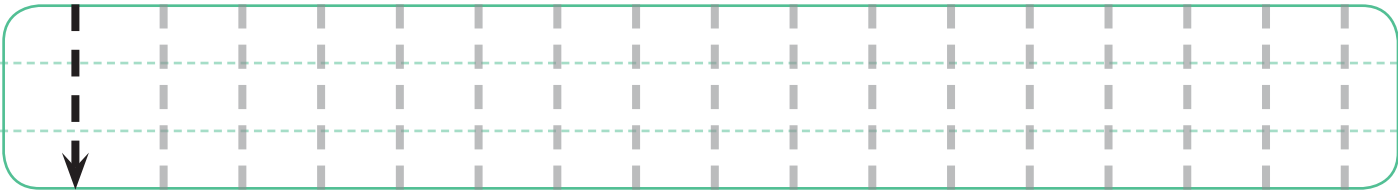
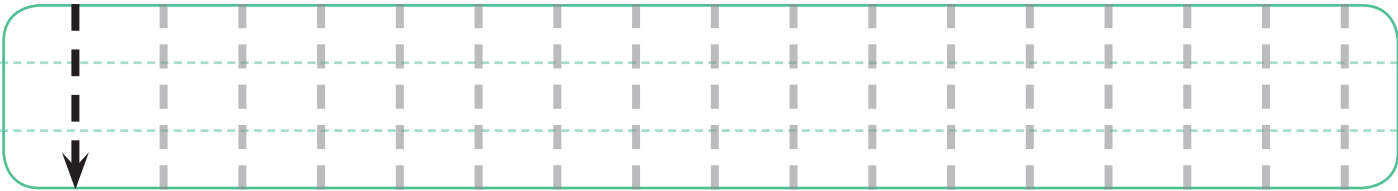
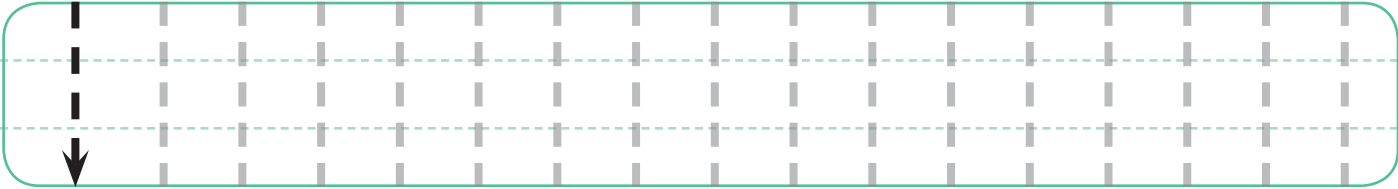

ÇİZGİ ÇALIŞMALARI

- Aşağıdakiler gibi yukarıdan aşağıya doğru kısa çizgiler çizin.



- Aşağıdaki solucanların üzerindeki noktaları birleştiriniz. Ardından siz de dik-katlice çizgiler çiziniz.

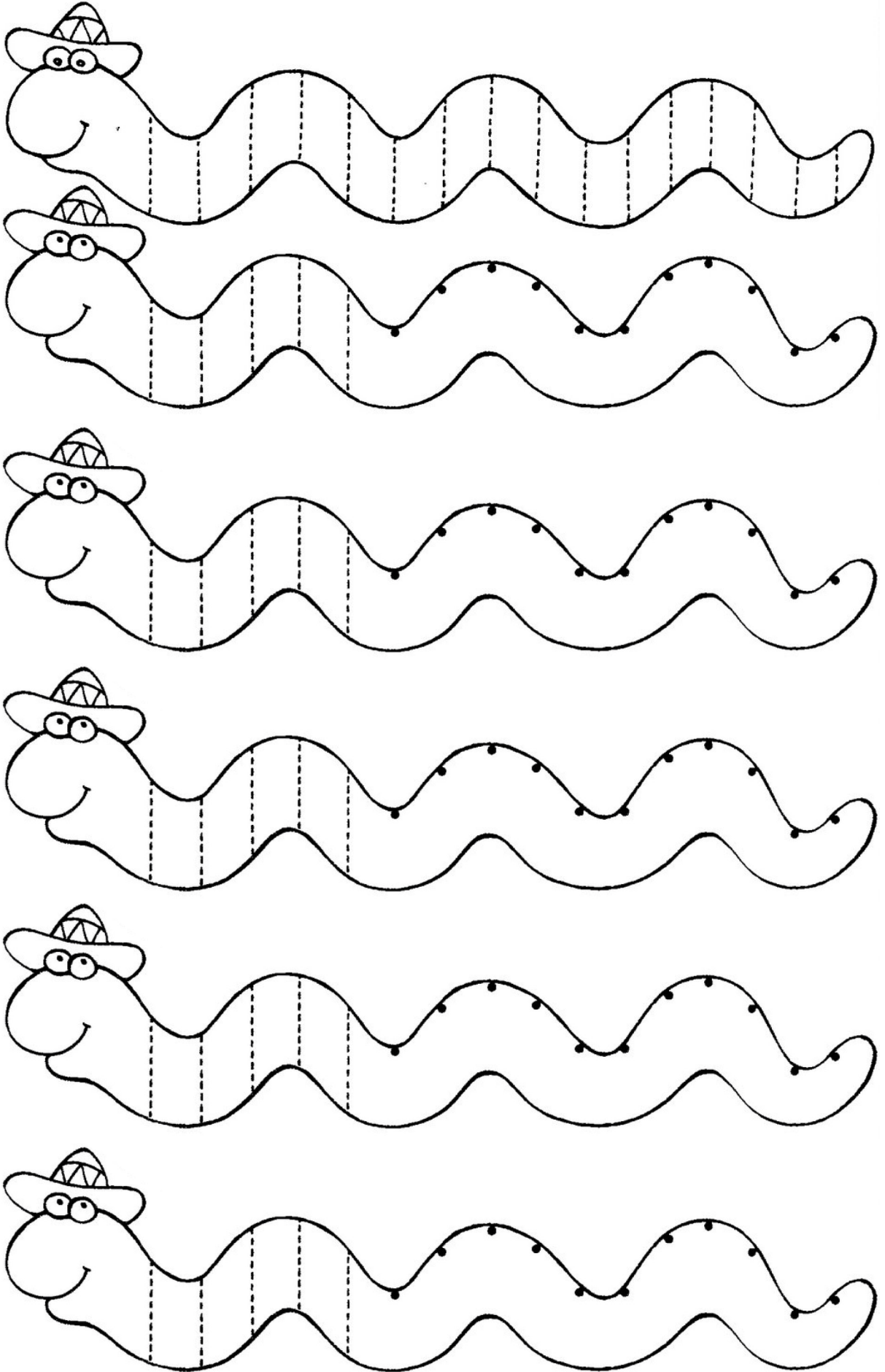

● Aşağıdaki hayvanları yaşam alanlarına ok yönüne dikkat ederek ulaştırınız.

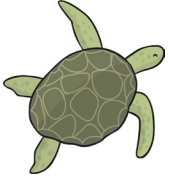
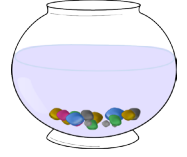
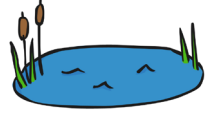

● Aşağıdaki noktaları belirtilen yönde birleştirerek çizgiler çizin.

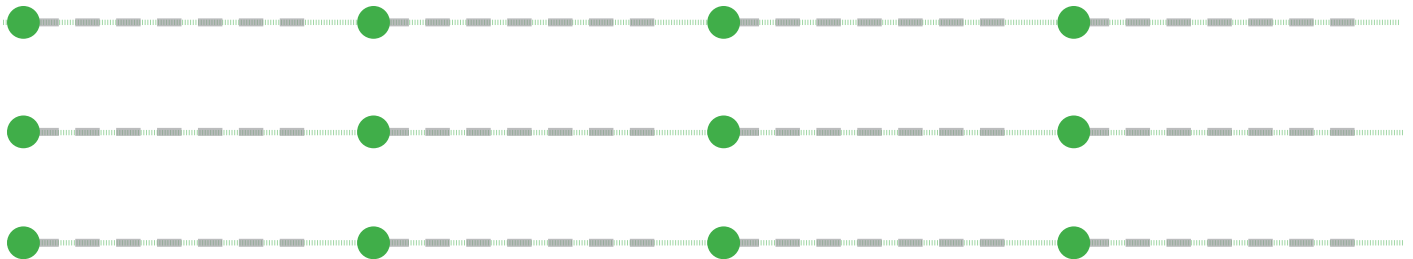
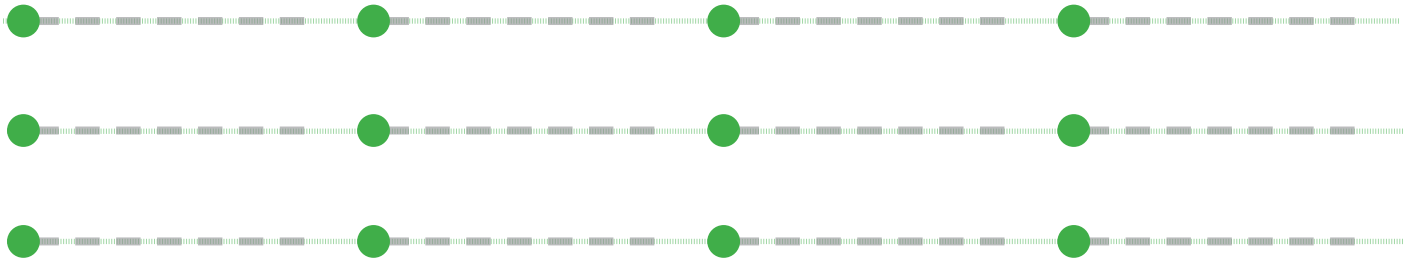
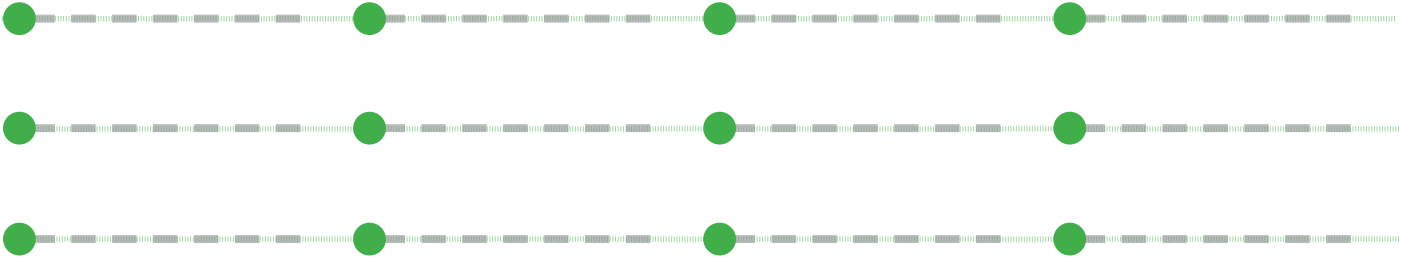
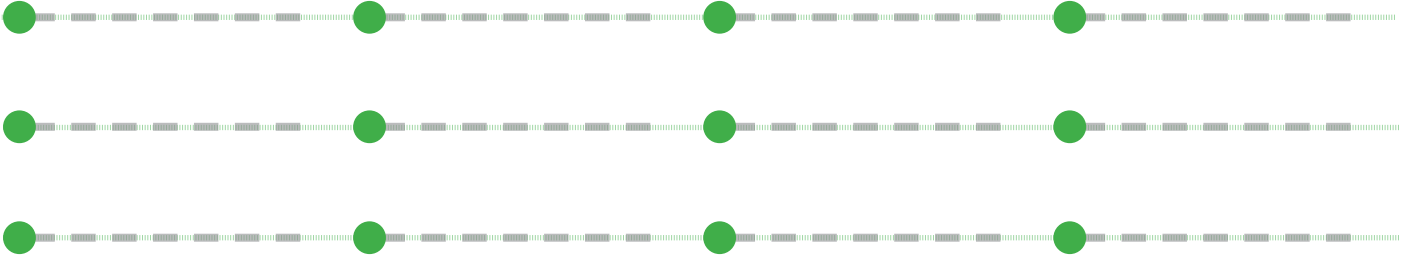
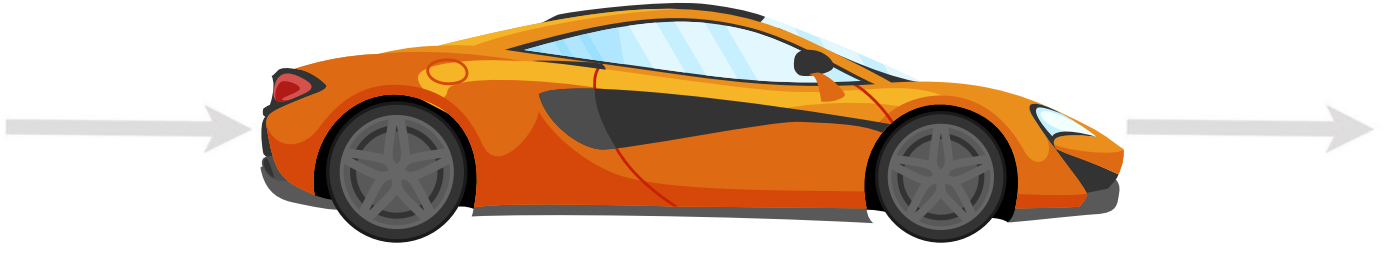

ÇİZGİ ÇALIŞMALARI

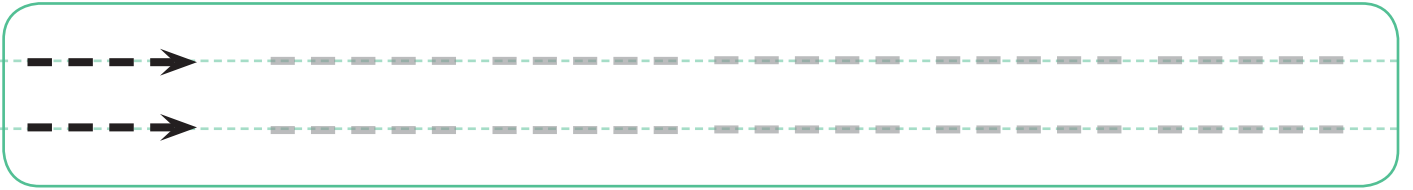
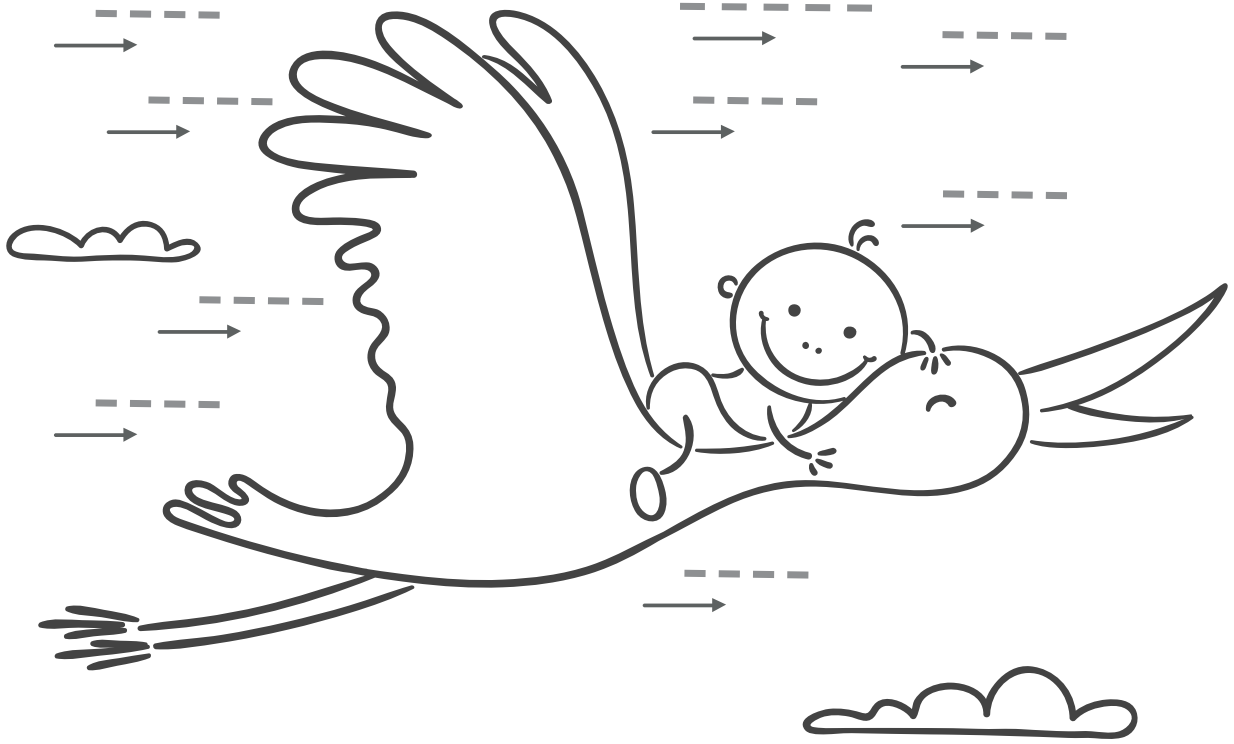



ÇİZGİ ÇALIŞMALARI

- Aşağıdakiler gibi soldan sağa doğru kısa çizgiler çizin.

Two horizontal lines with arrows pointing right, followed by two dashed lines for tracing.

Two horizontal lines with arrows pointing right, followed by two dashed lines for tracing.

Two horizontal lines with arrows pointing right, followed by two dashed lines for tracing.

Two horizontal lines with arrows pointing right, followed by two dashed lines for tracing.

Two horizontal lines with arrows pointing right, followed by two dashed lines for tracing.

Two horizontal lines with arrows pointing right, followed by two dashed lines for tracing.

Two horizontal lines with arrows pointing right, followed by two dashed lines for tracing.

Two horizontal lines with arrows pointing right, followed by two dashed lines for tracing.

● Aşağıdaki noktaları soldan sağa doğru birleştiriniz. Ardından siz de dikkatlice çizgiler çiziniz.

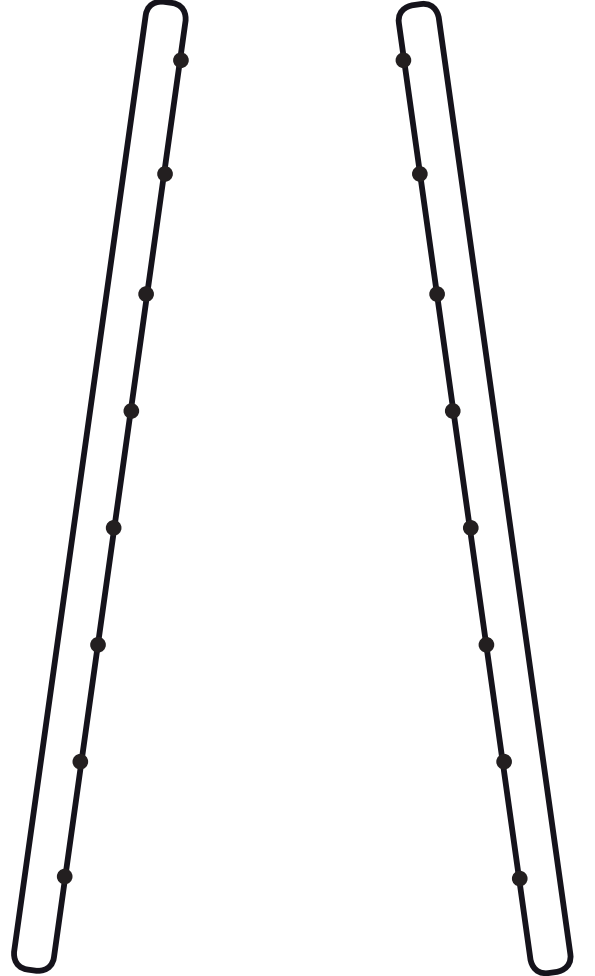
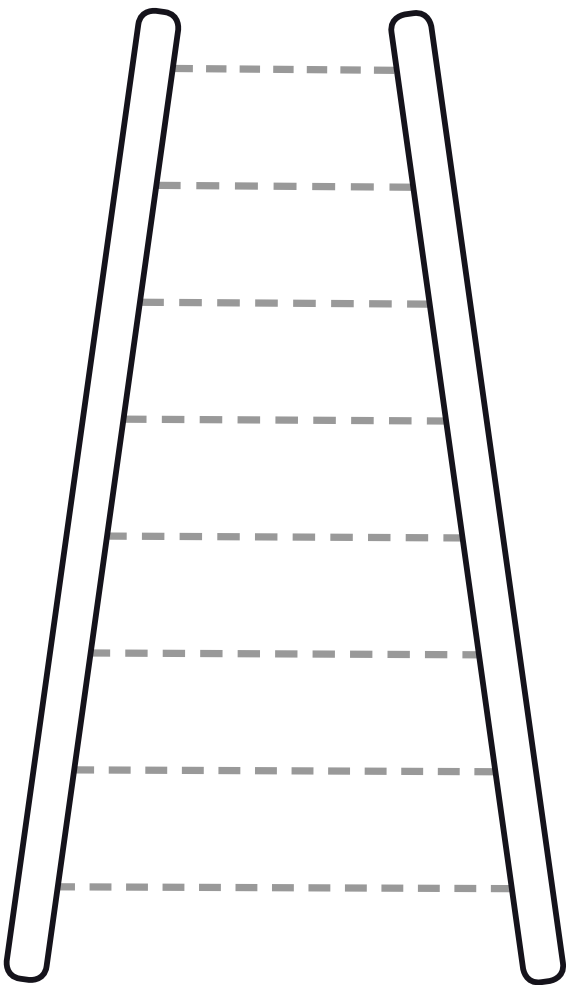
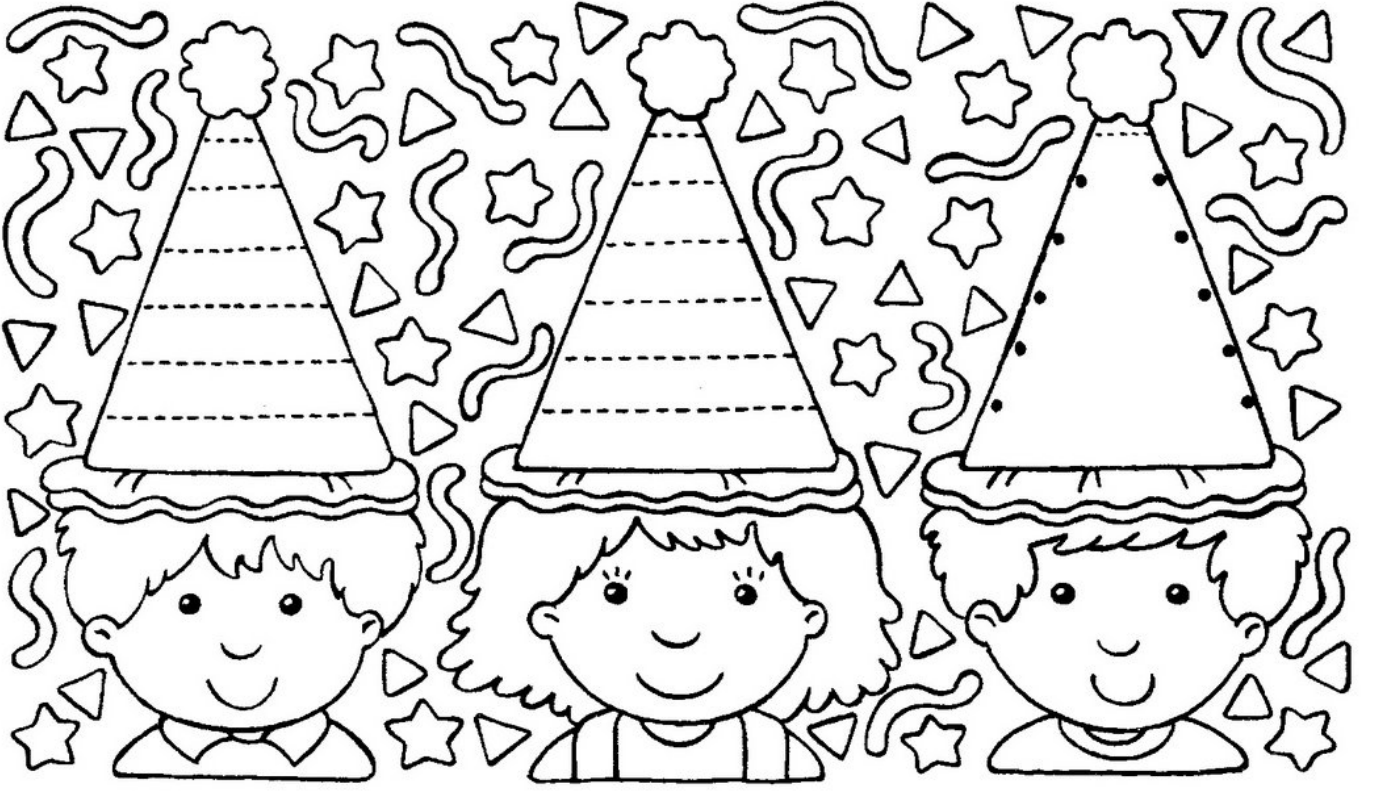

ÇİZGİ ÇALIŞMALARI

- Aşağıdaki noktaları ok yönünde doğru birleştirerek kısa çizgiler çizin.

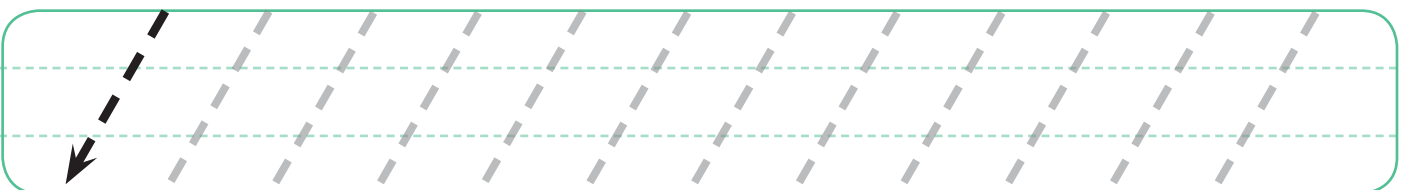
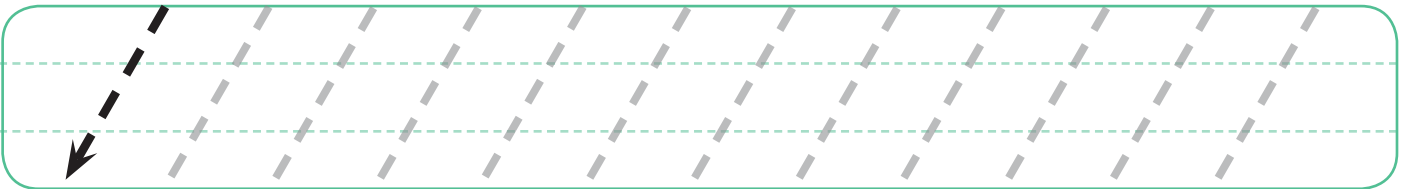
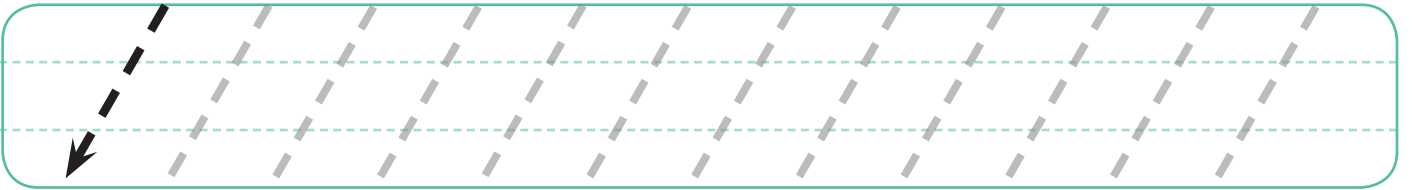
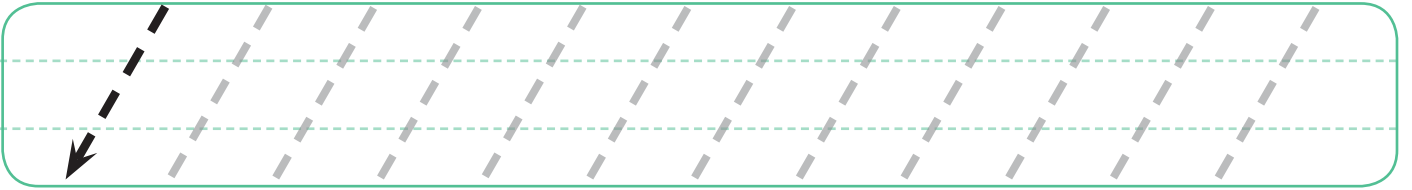
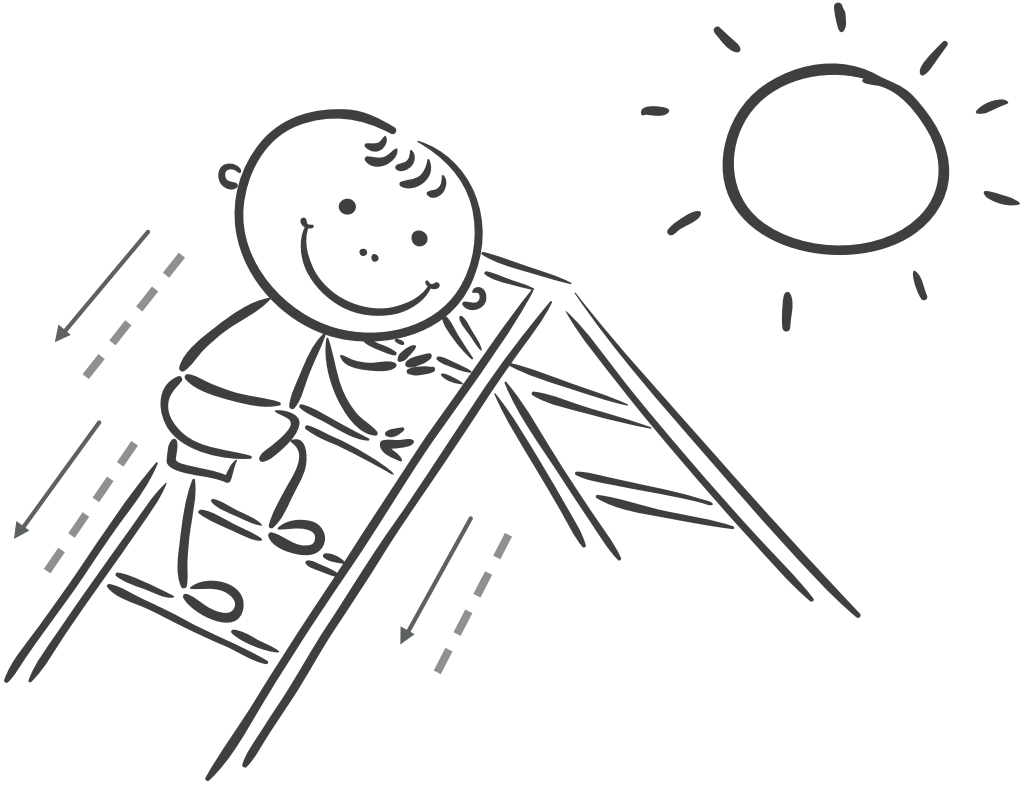

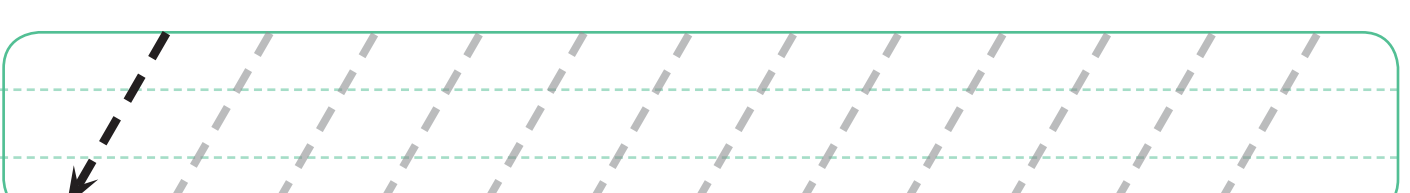
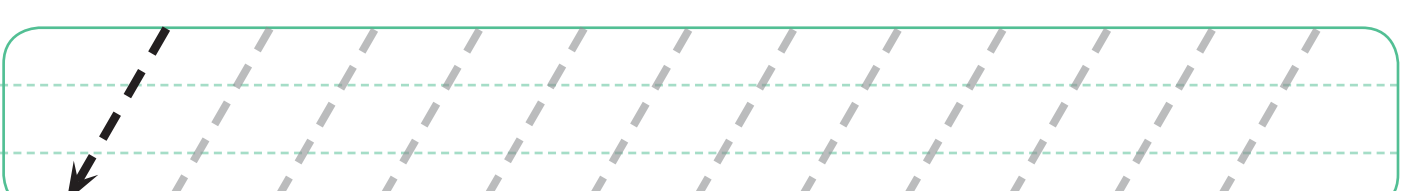
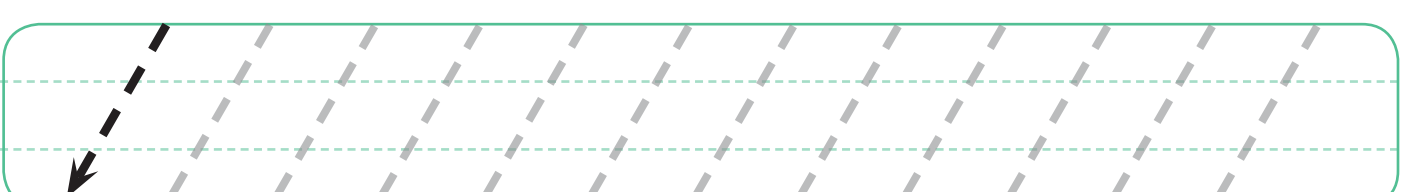
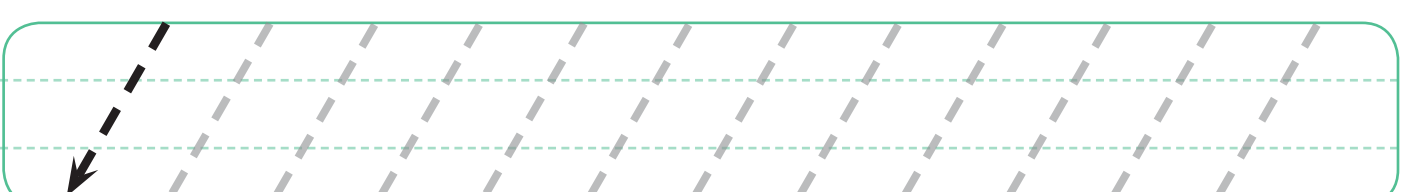
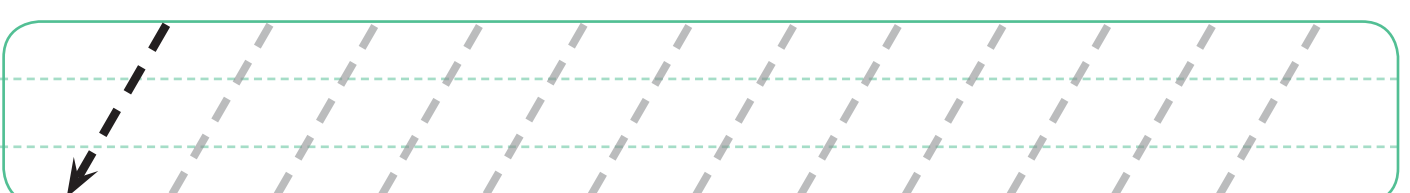
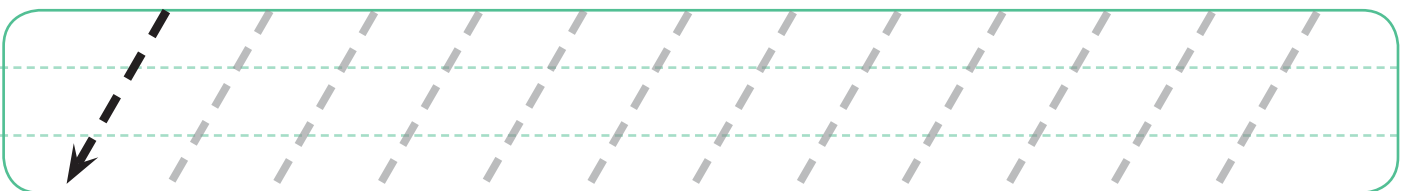
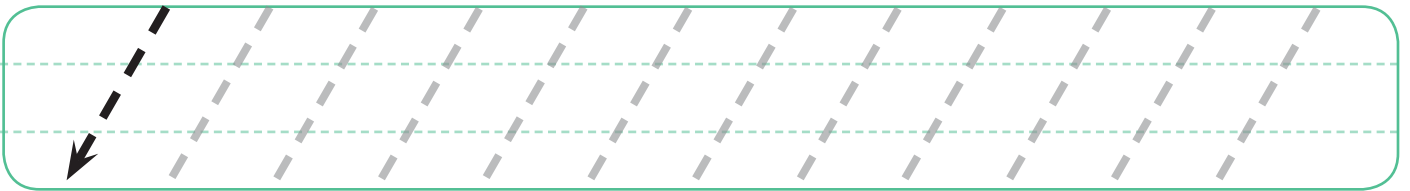
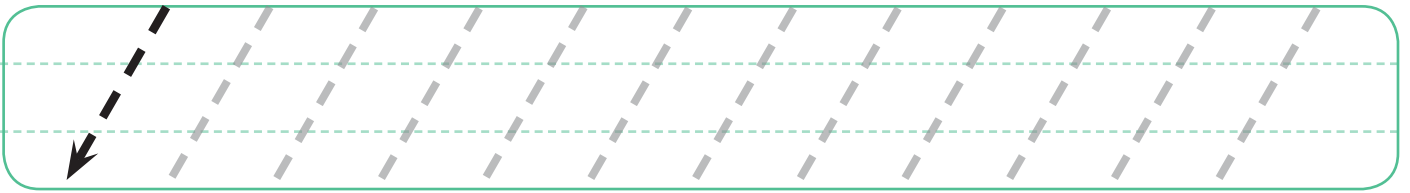
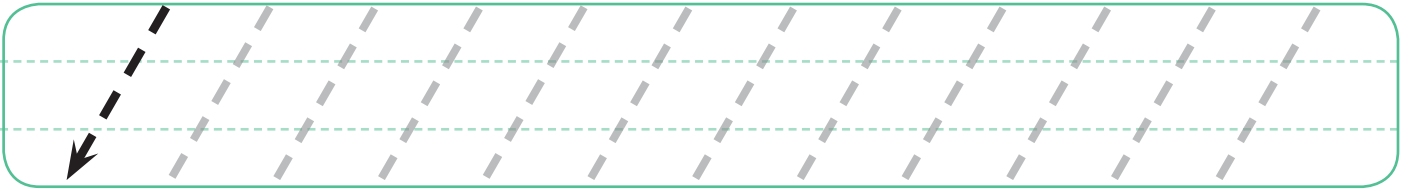

ÇİZGİ ÇALIŞMALARI

- Aşağıdakiler gibi ok yönünde kısa çizgiler çiziniz.



● Aşağıdaki noktaları belirtilen yönde birleştirerek çizgiler çiziniz.

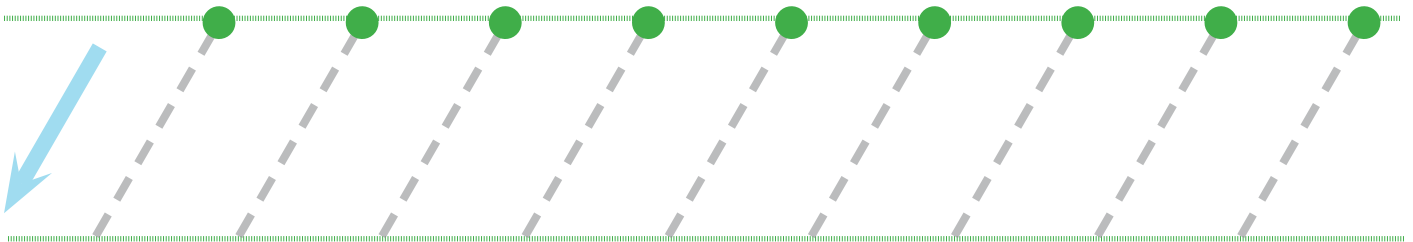
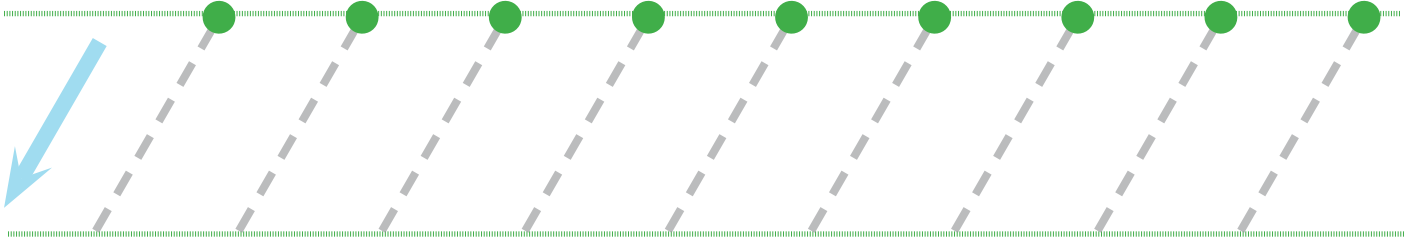
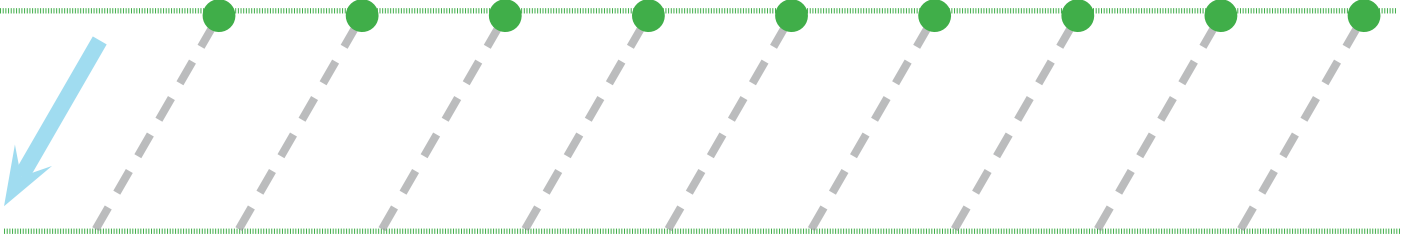
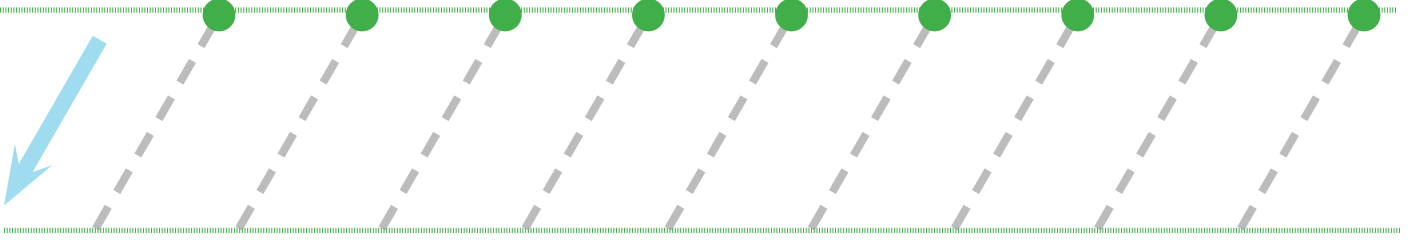
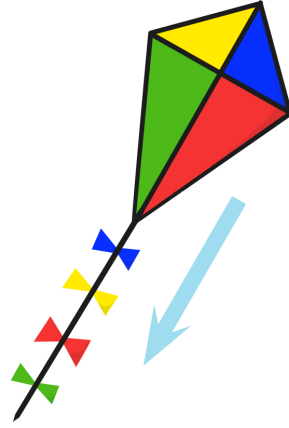
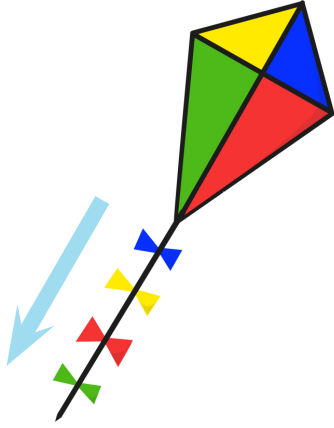

ÇİZGİ ÇALIŞMALARI

- Aşağıdaki noktaları ok yönünde doğru birleştirerek kısa çizgiler çizin.

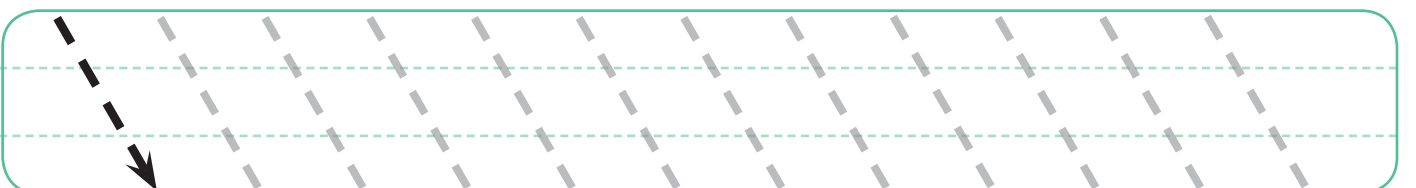
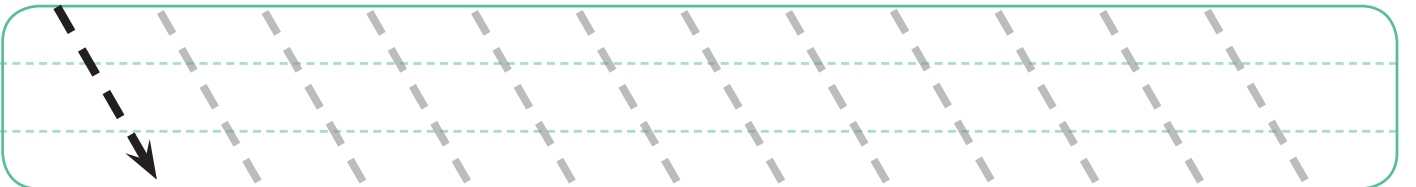
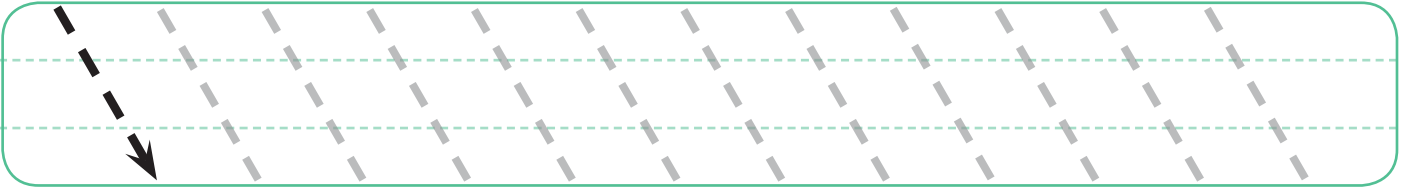
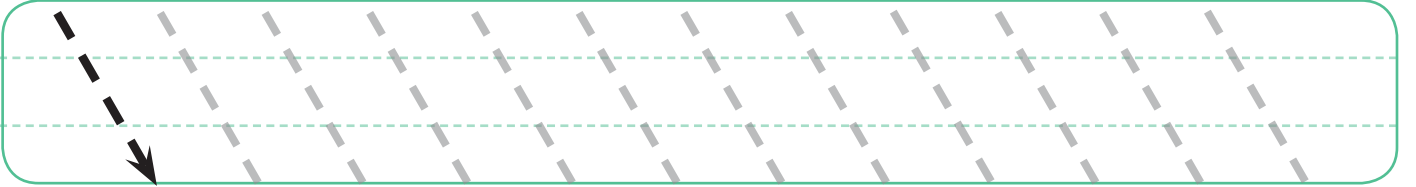

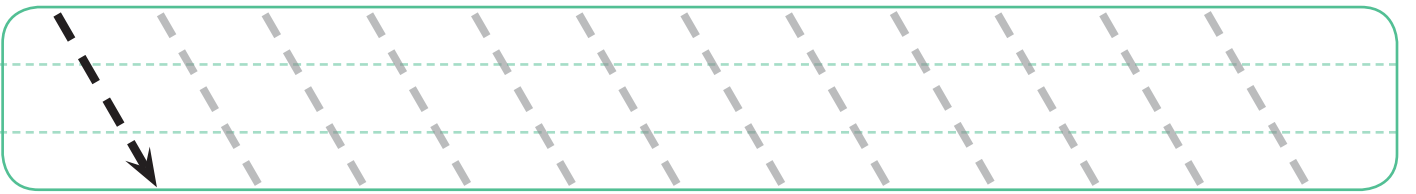
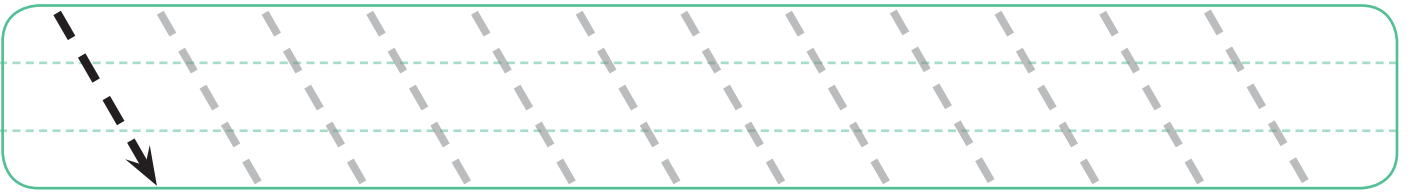
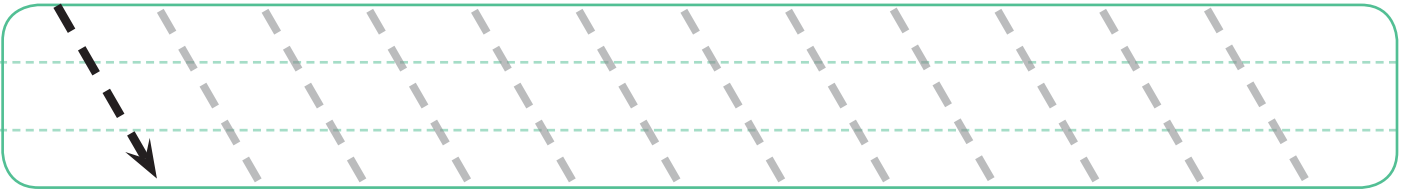
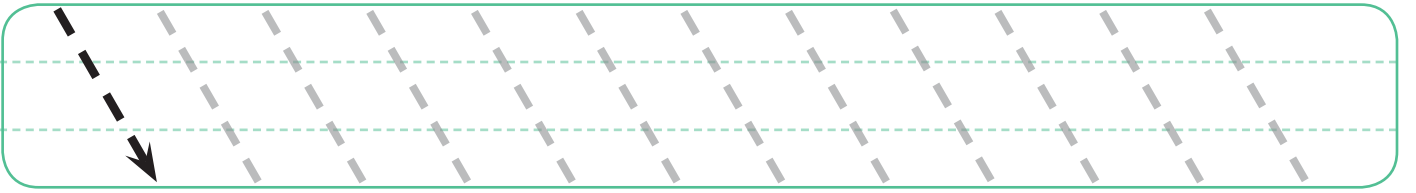
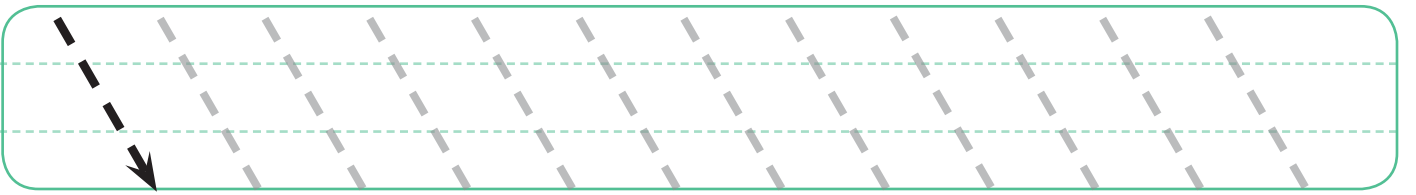
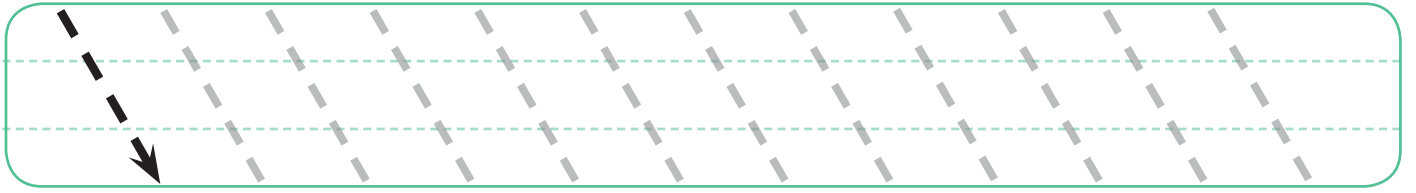
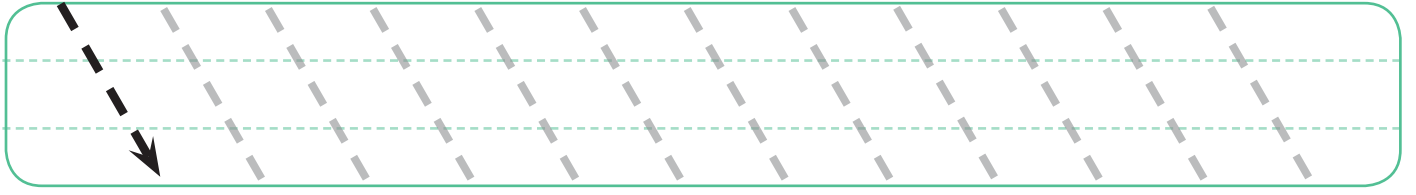
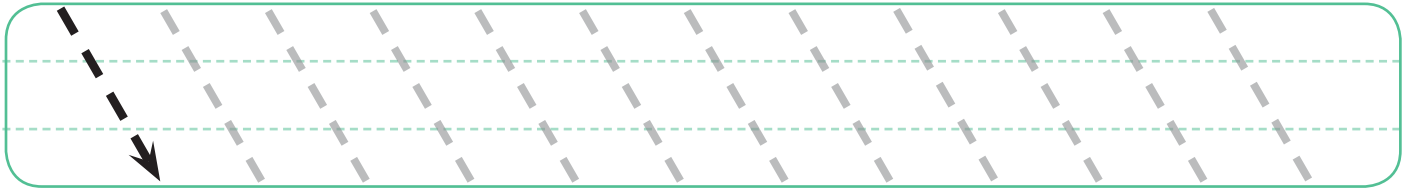
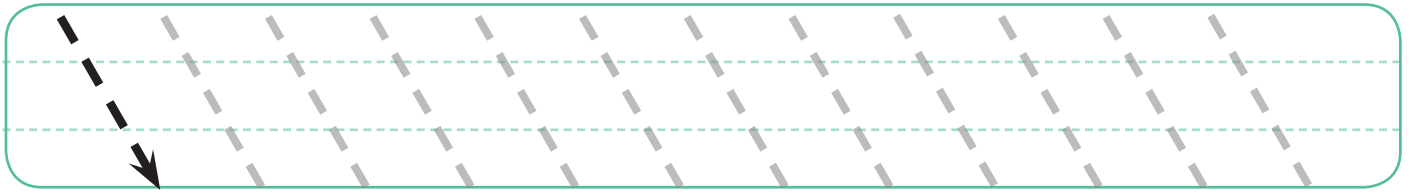

ÇİZGİ ÇALIŞMALARI

- Aşağıdakiler gibi ok yönünde kısa çizgiler çiziniz.



● Aşağıdaki noktaları belirtilen yönde birleştirerek çizgiler çiziniz.

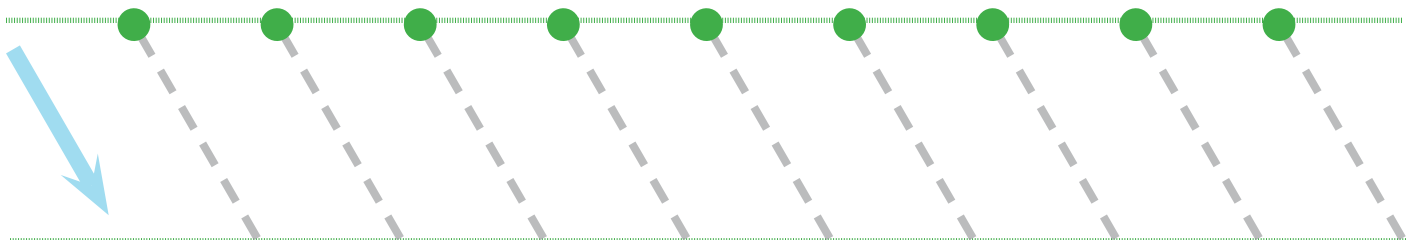
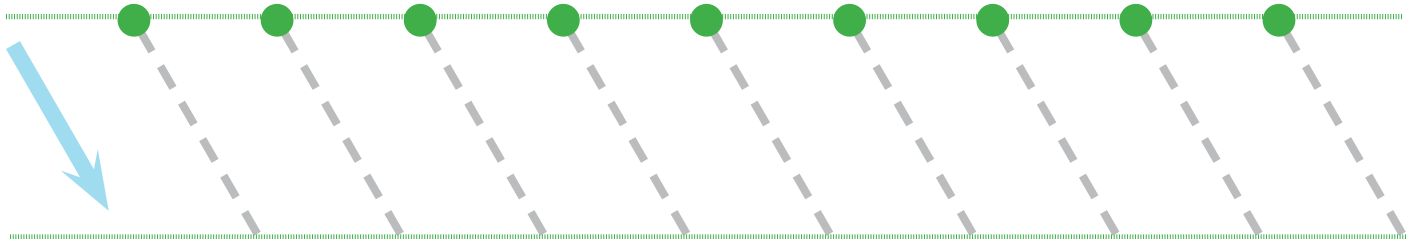
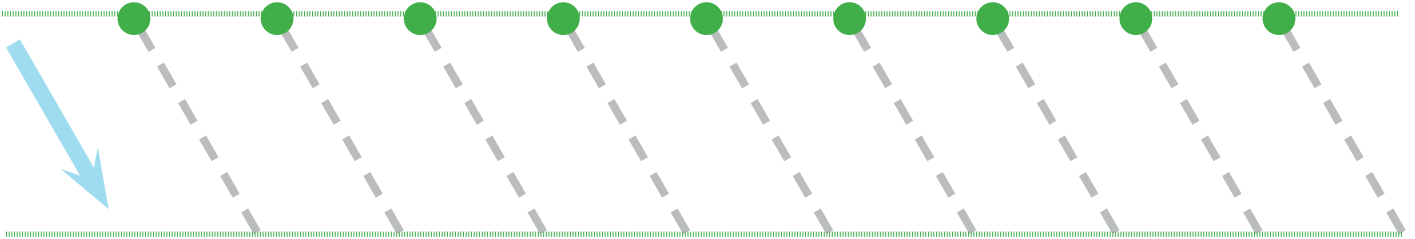
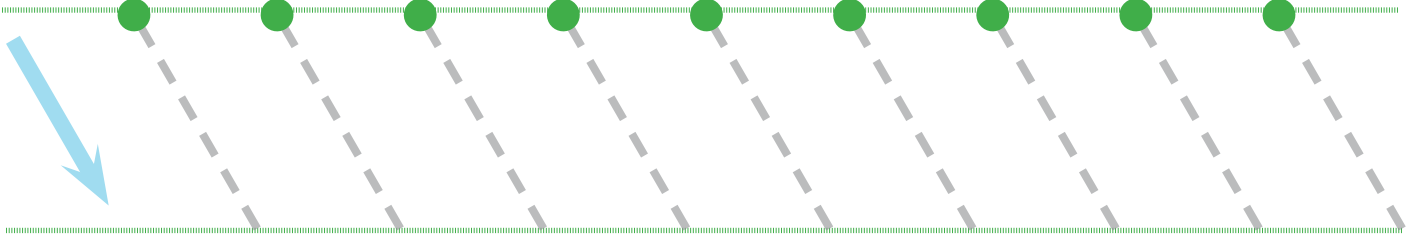
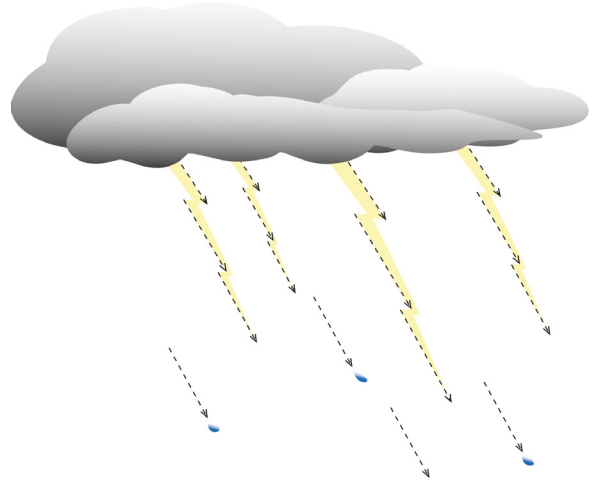
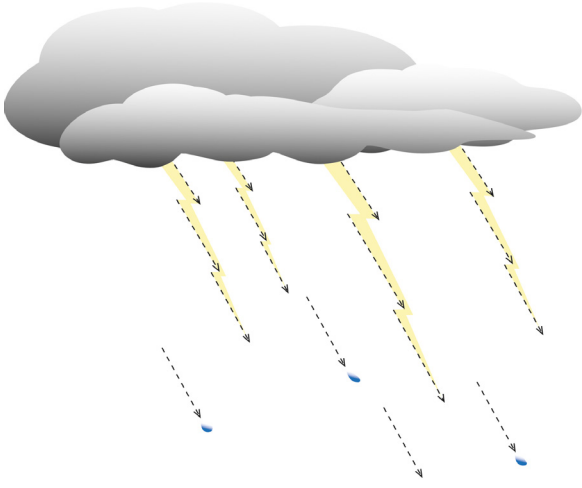

ÇİZGİ ÇALIŞMALARI

- Aşağıdaki kesik çizgileri ok yönünde birleştiriniz.

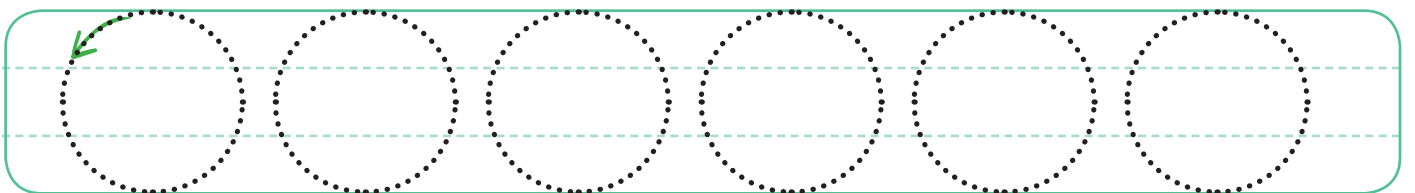
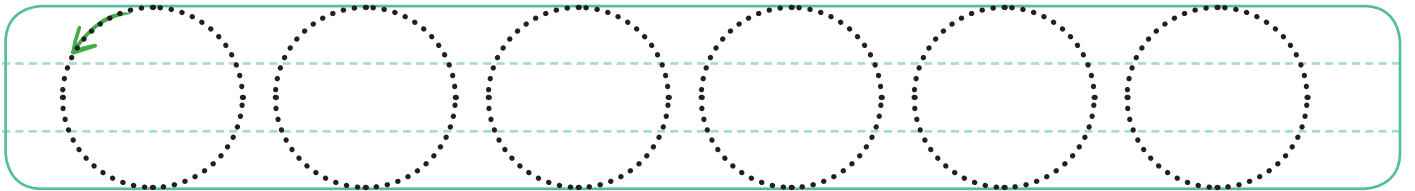
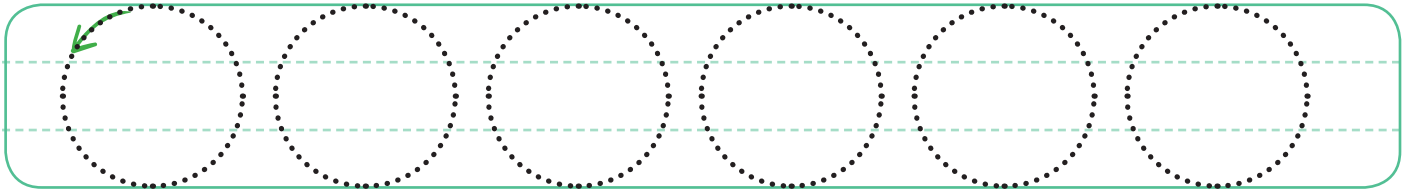
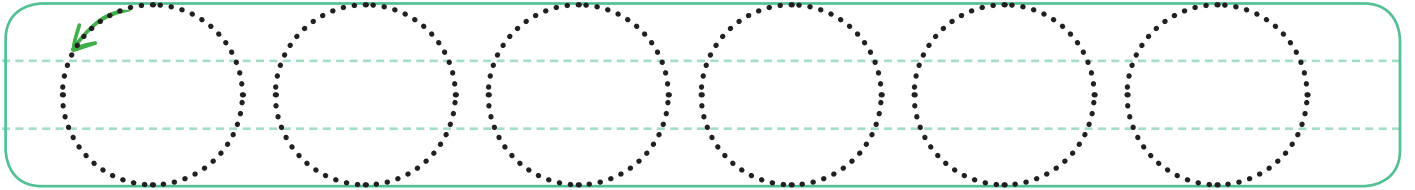
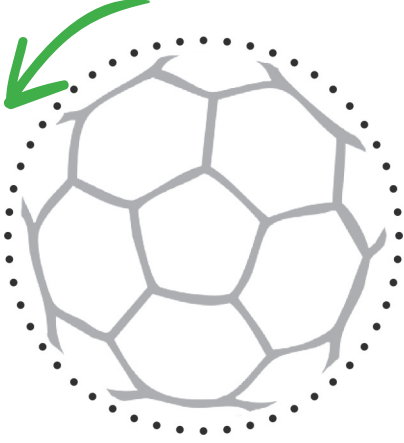

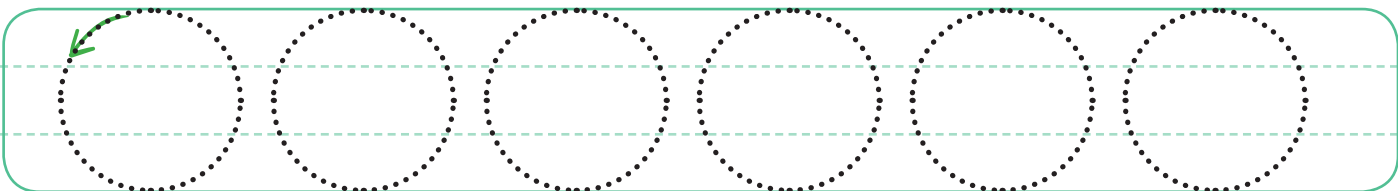
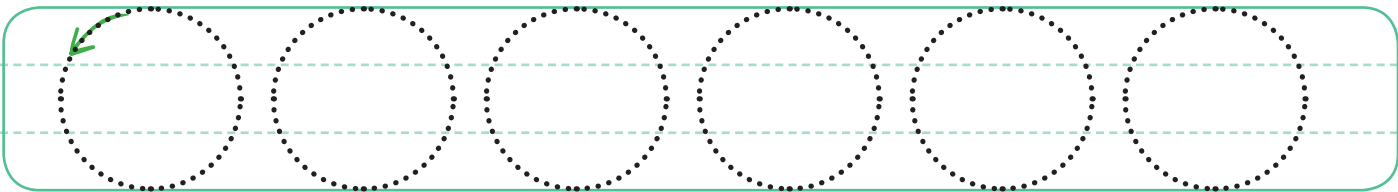
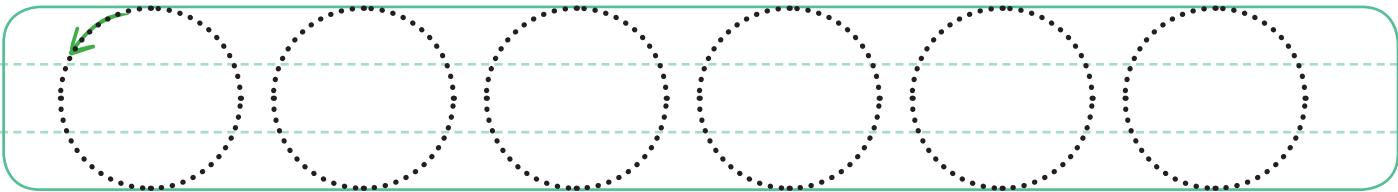
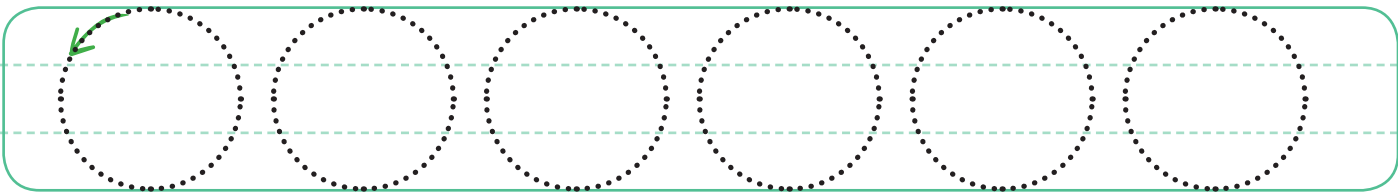
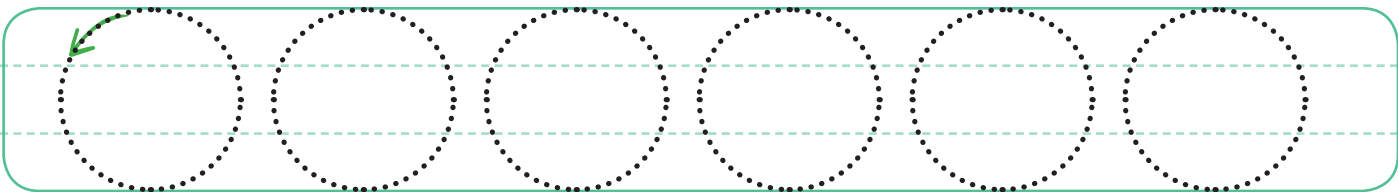
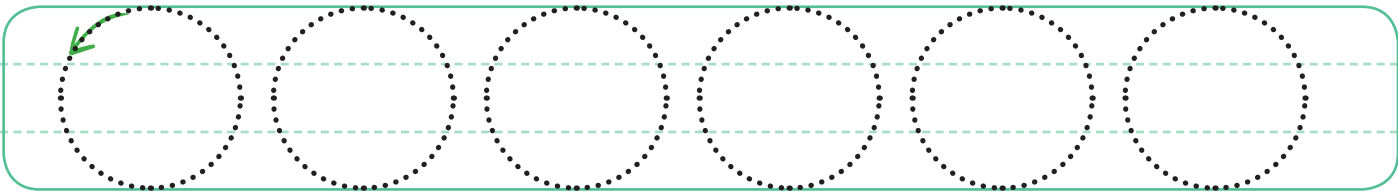
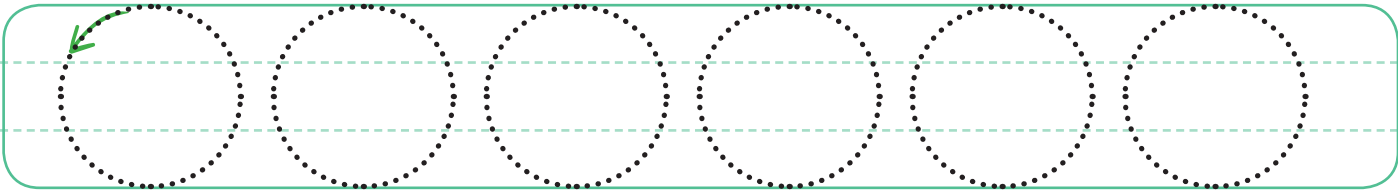
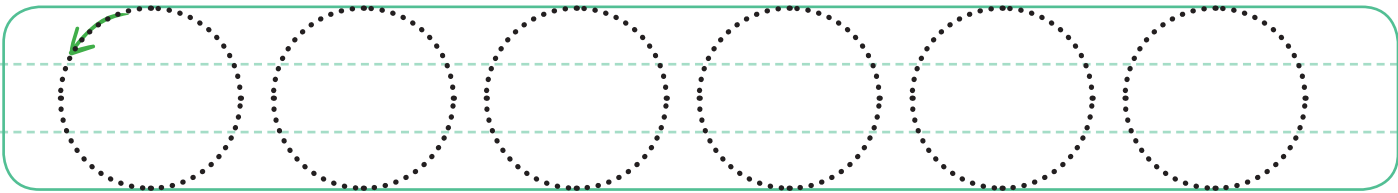
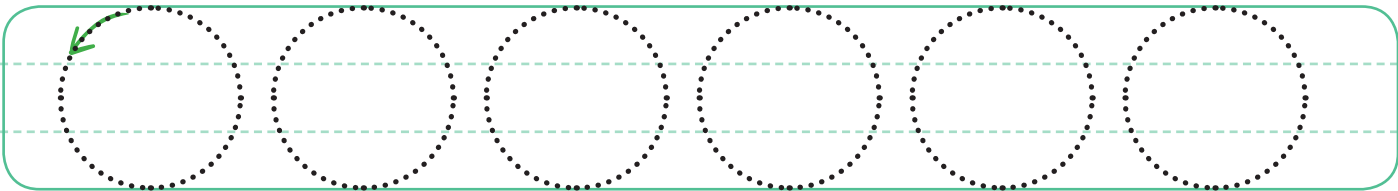

● Aşağıdaki noktaları belirtilen yönde birleştirerek çizgiler çizin.

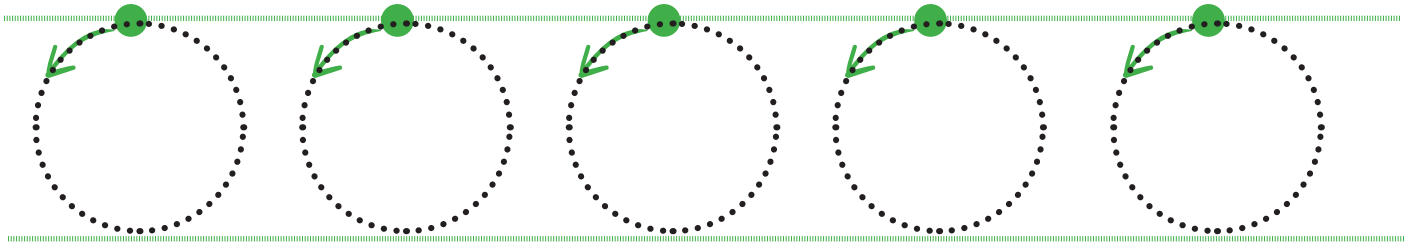
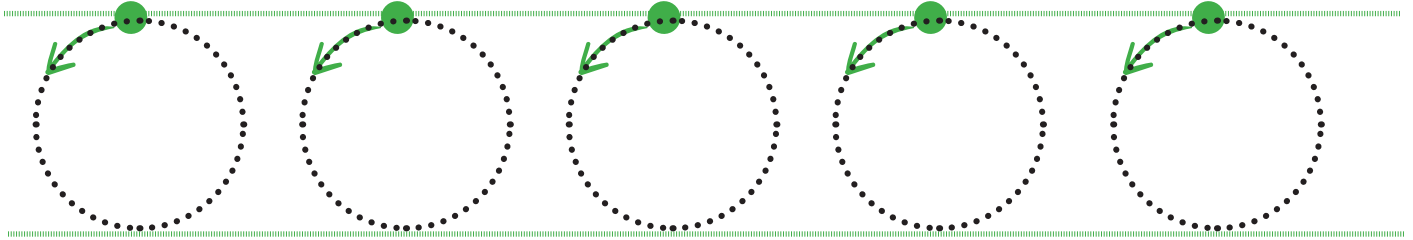
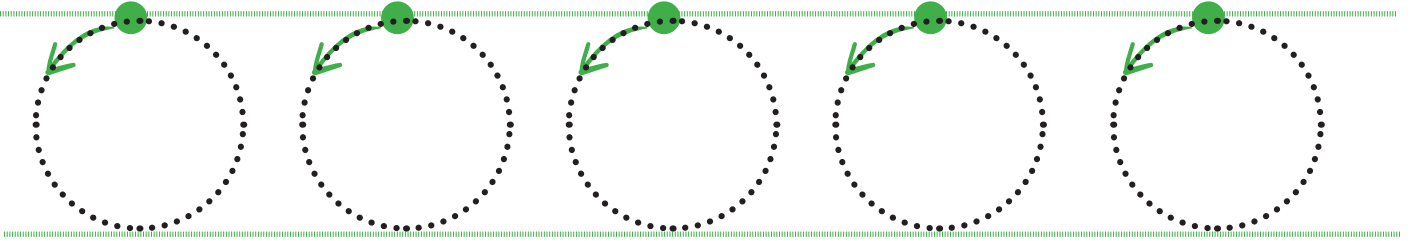
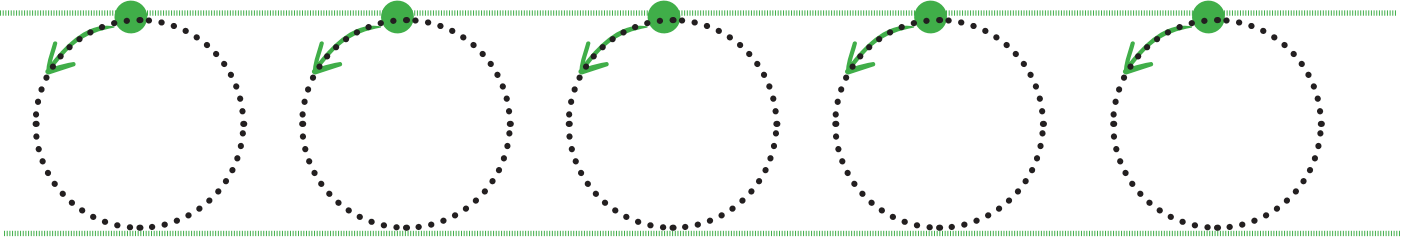
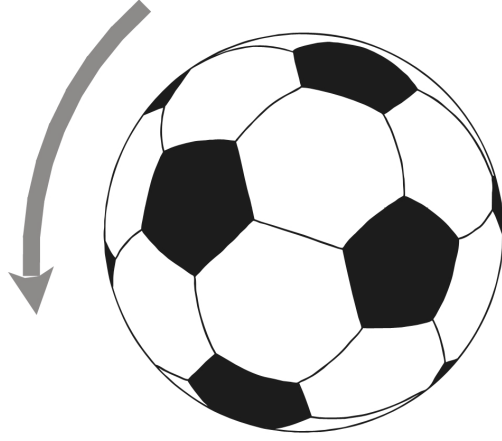

● Aşağıdaki noktaları belirtilen yönde birleştirerek çizgiler çiziniz.



ÇİZGİ ÇALIŞMALARI

- Aşağıdaki kesik çizgileri ok yönünde birleştiriniz.

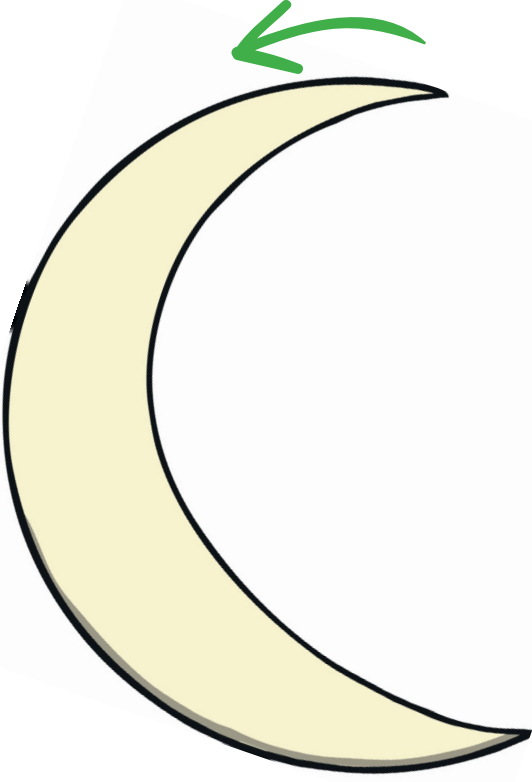

Four rows of tracing practice for the letter 'C'. Each row contains six dashed 'C' shapes. The first 'C' in each row has a green arrow pointing left at the top, indicating the starting point and direction of the stroke.

● Aşağıdaki noktaları belirtilen yönde birleştirerek çizgiler çizin.

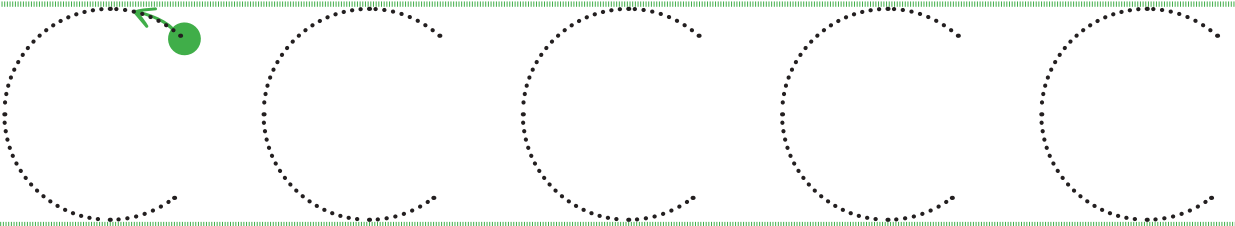
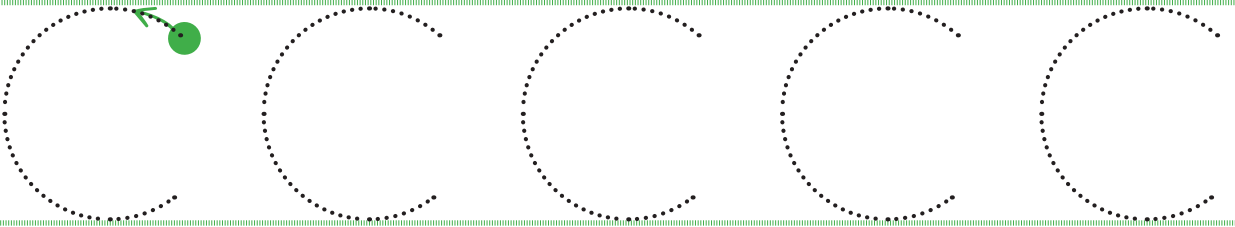
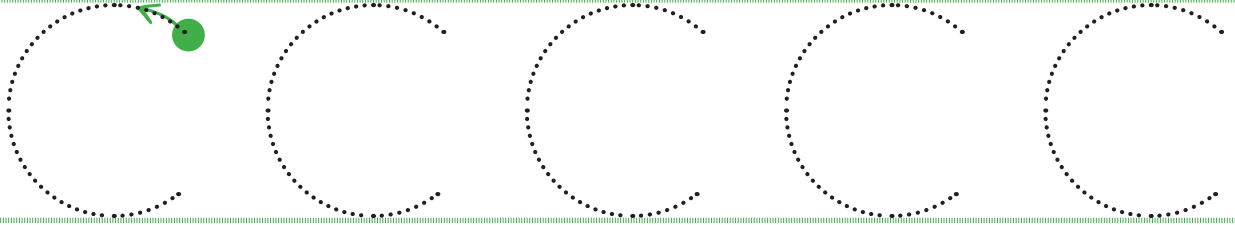
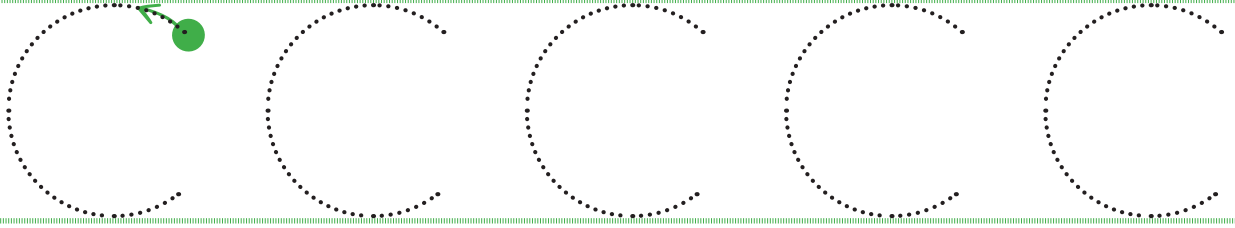
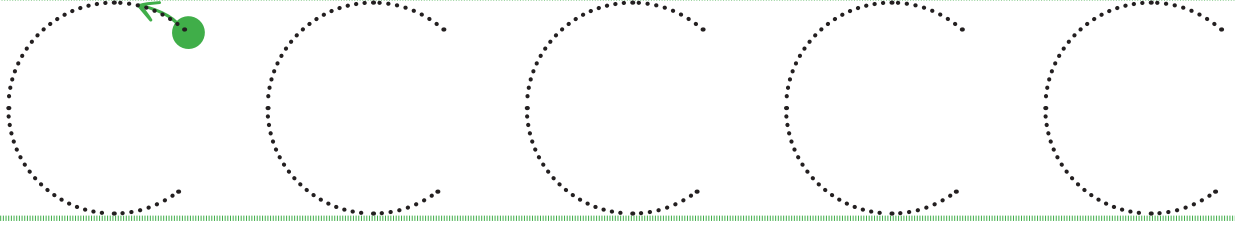
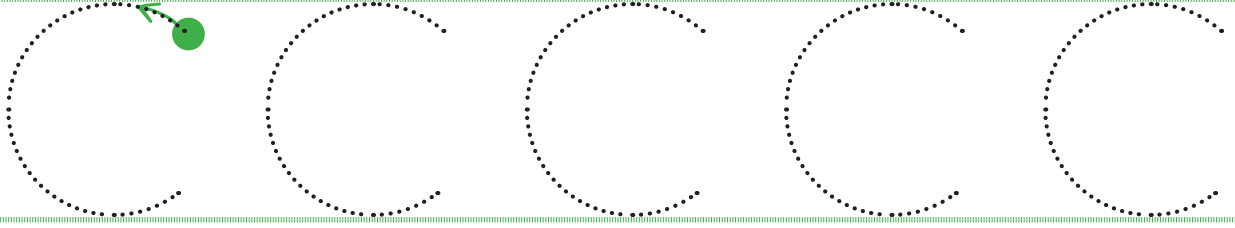

ÇİZGİ ÇALIŞMALARI

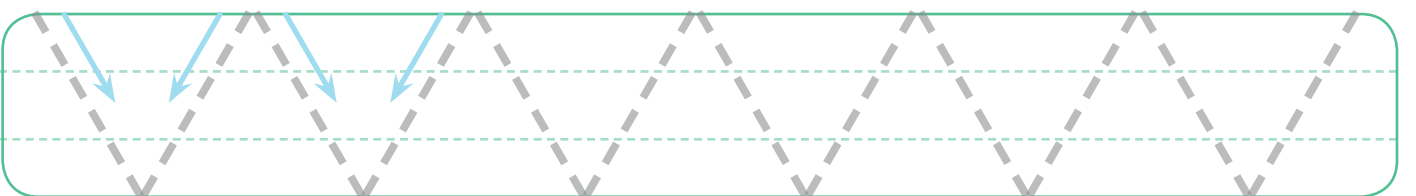
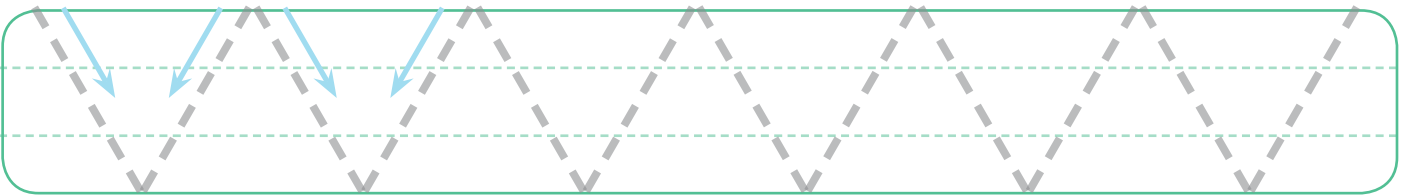
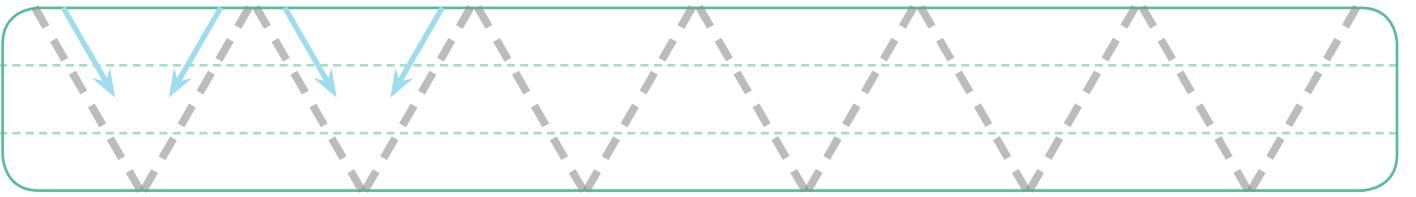
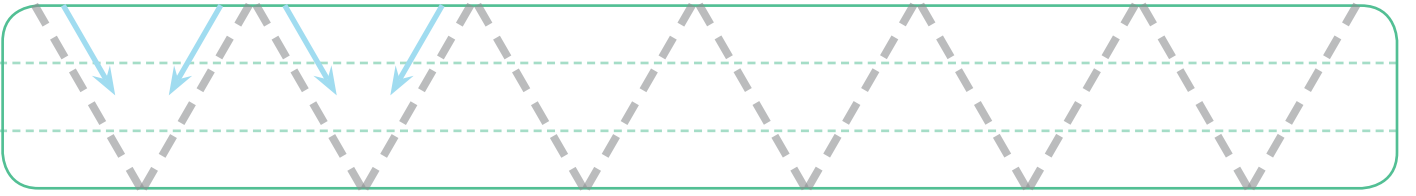
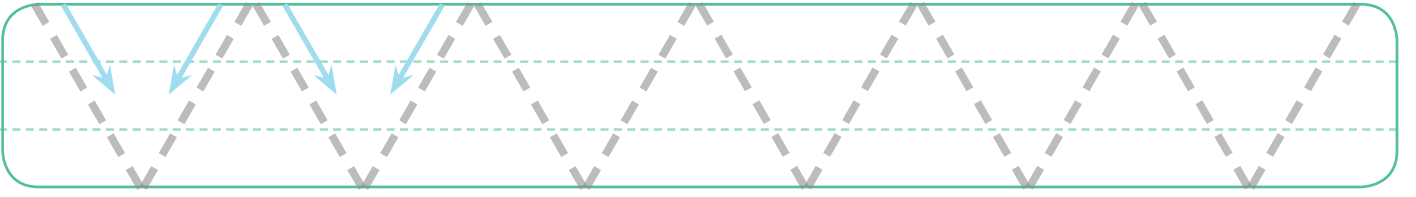
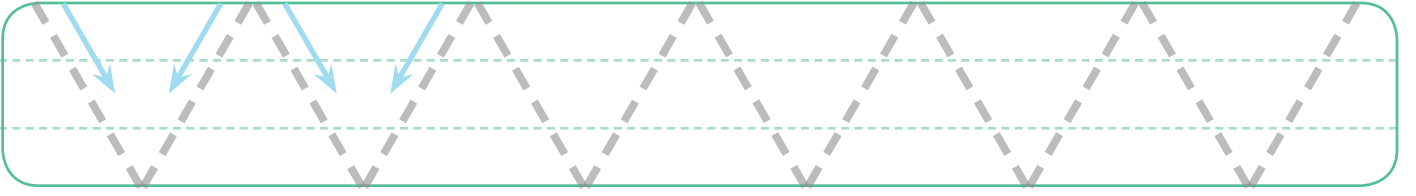
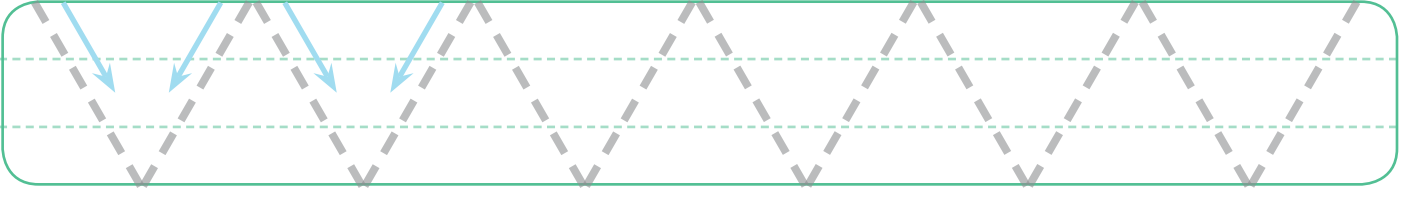
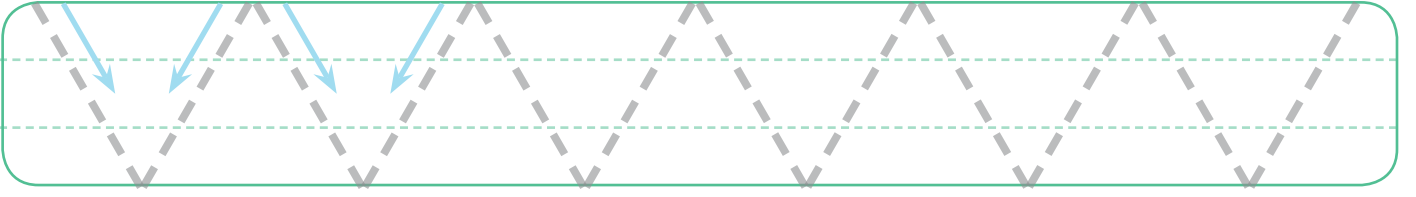

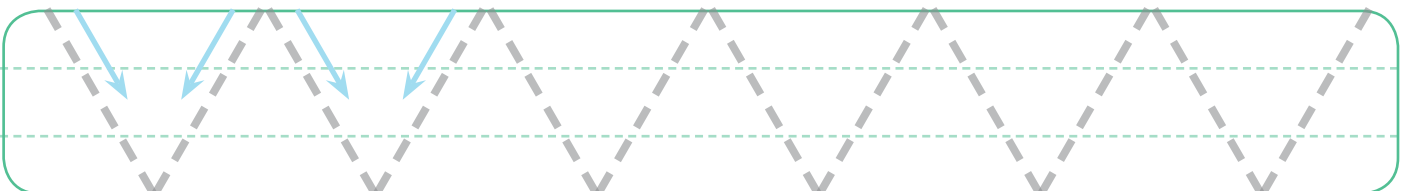
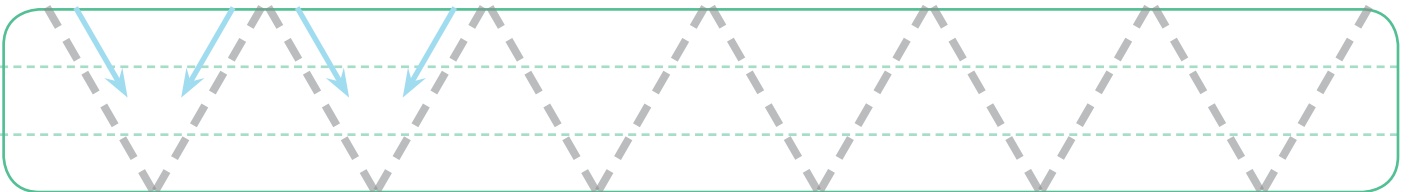
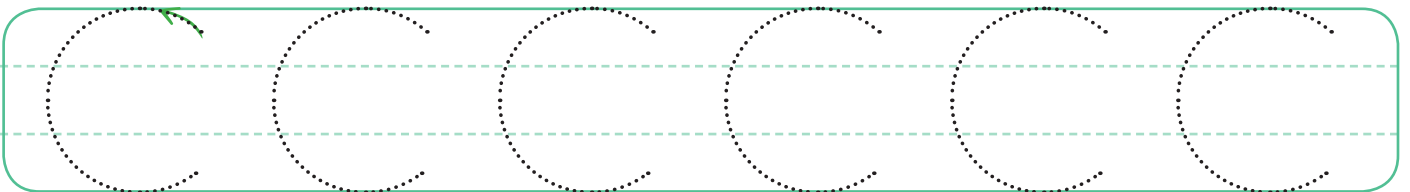
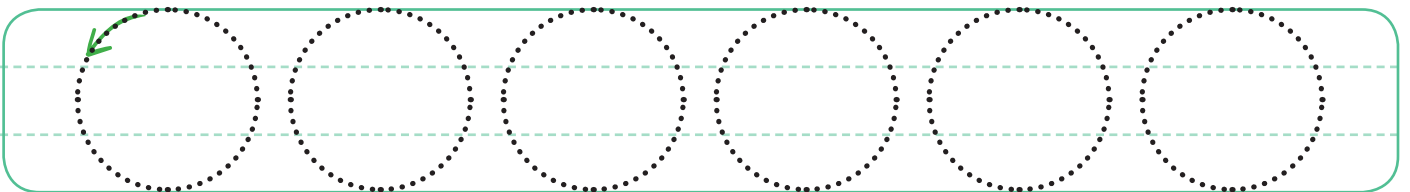
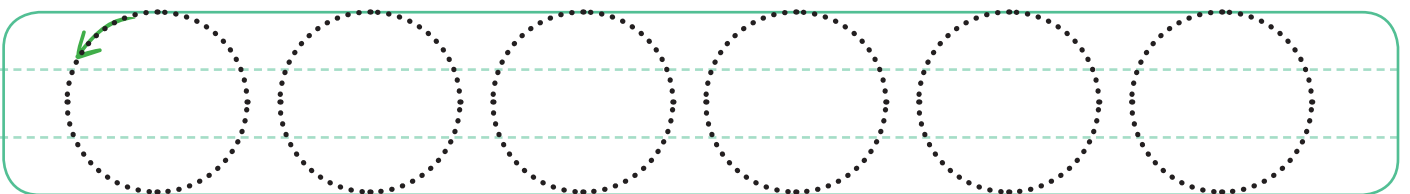
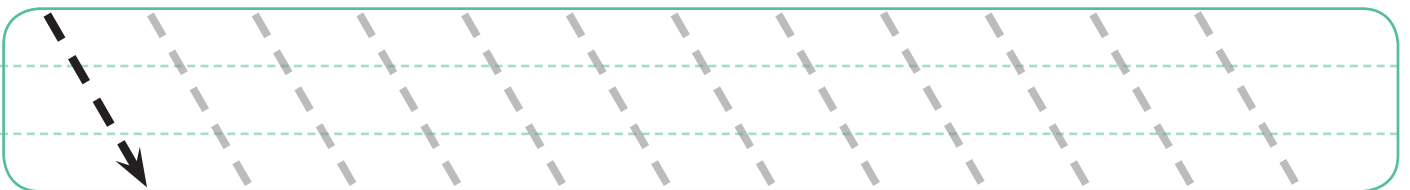
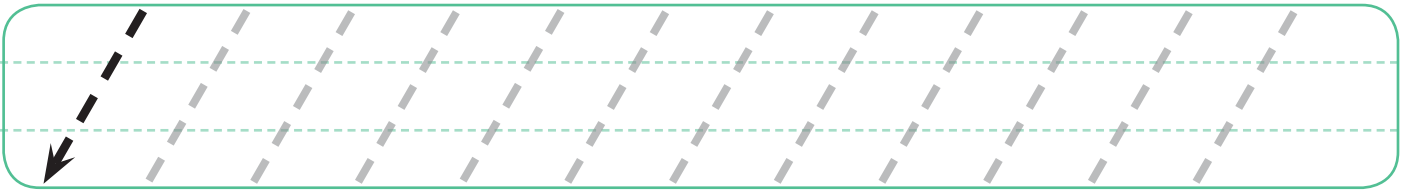
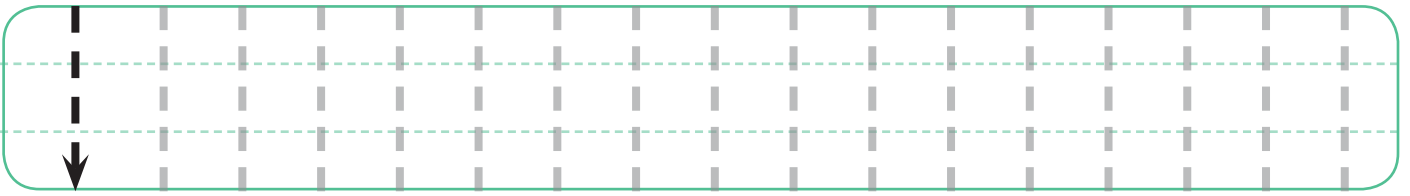

ÇİZGİ ÇALIŞMALARI

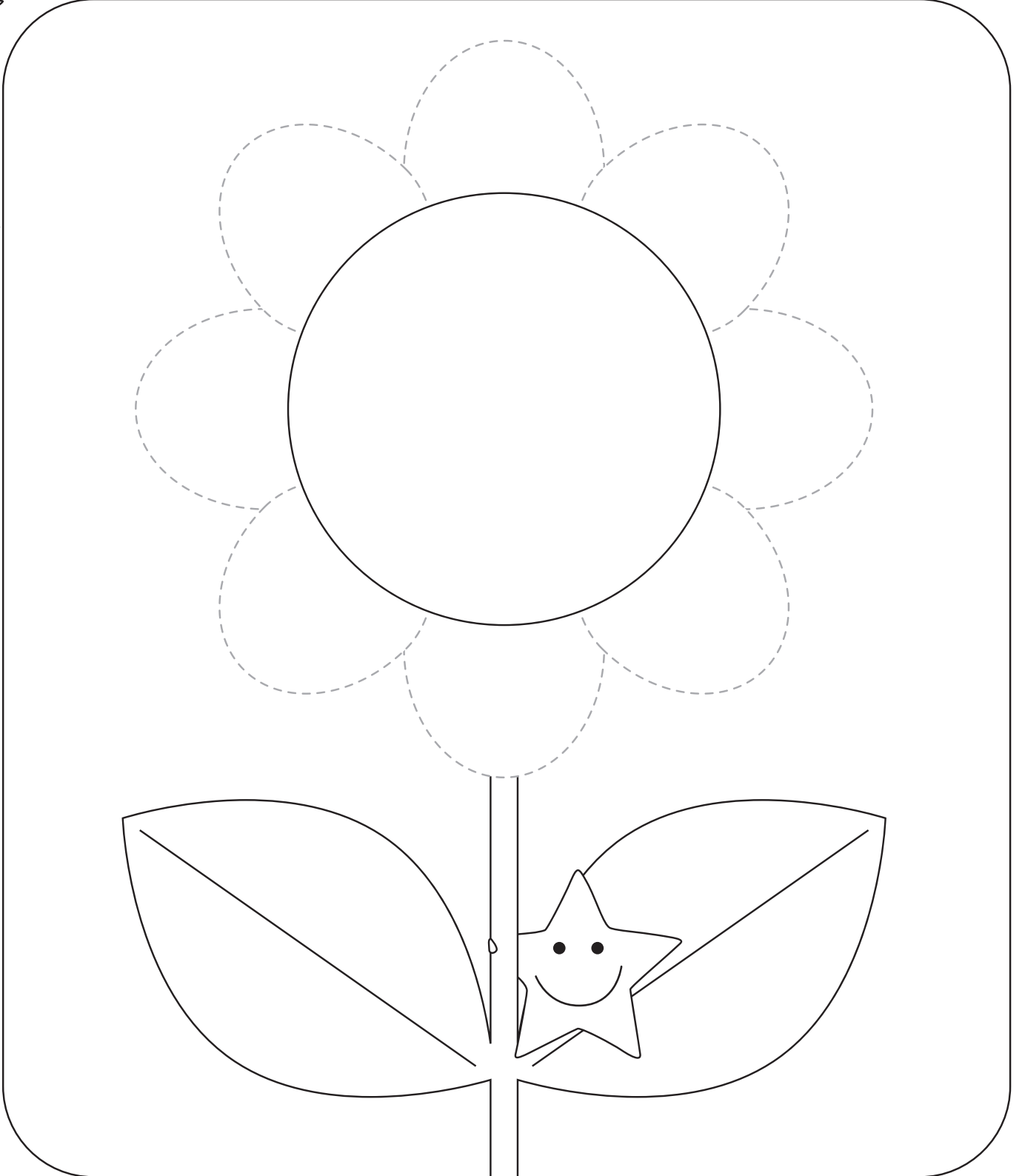
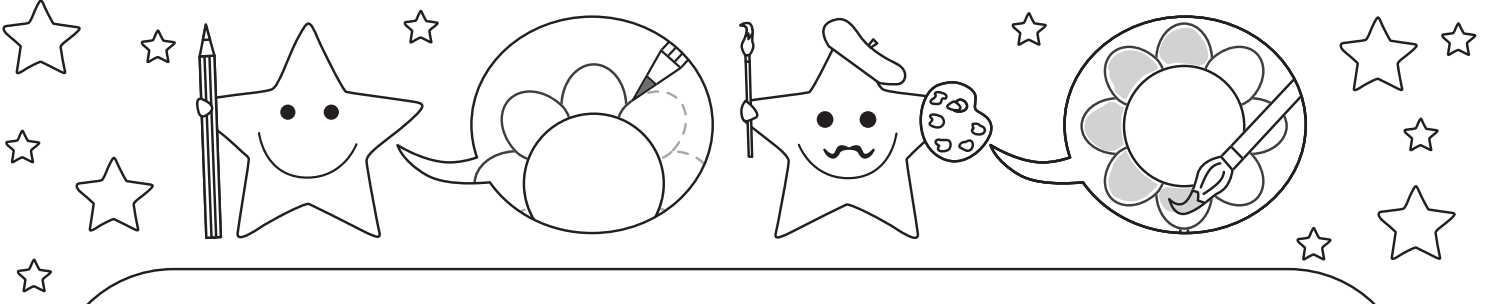

ÇİZGİ ÇALIŞMALARI

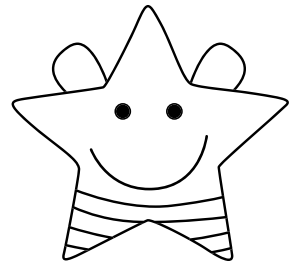
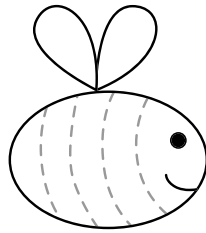
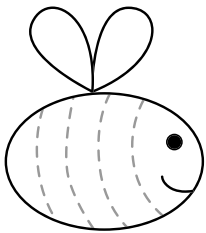
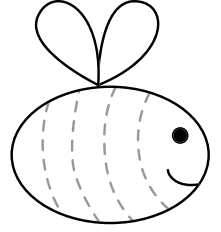
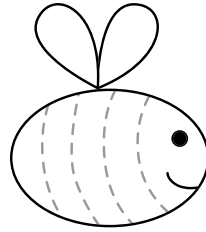
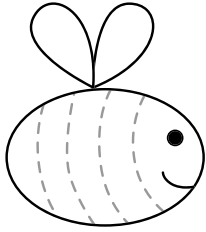
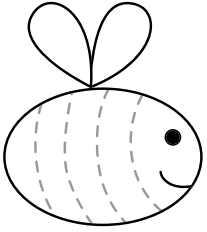
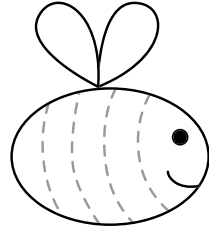
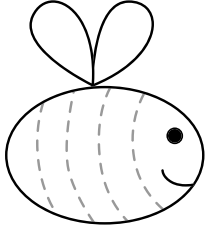
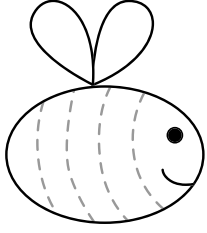
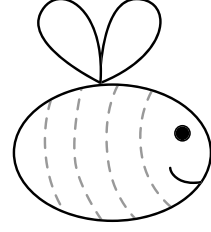
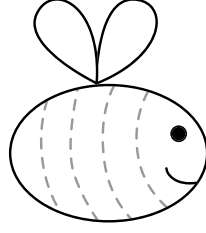
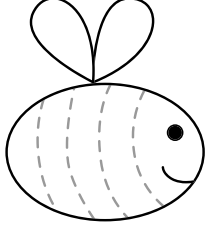
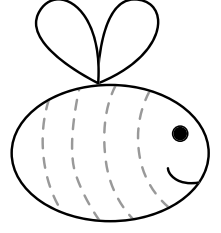
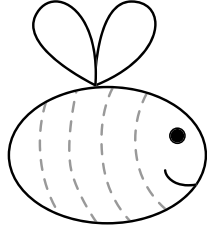
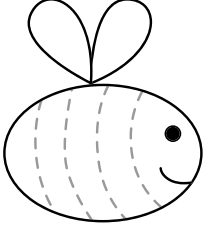
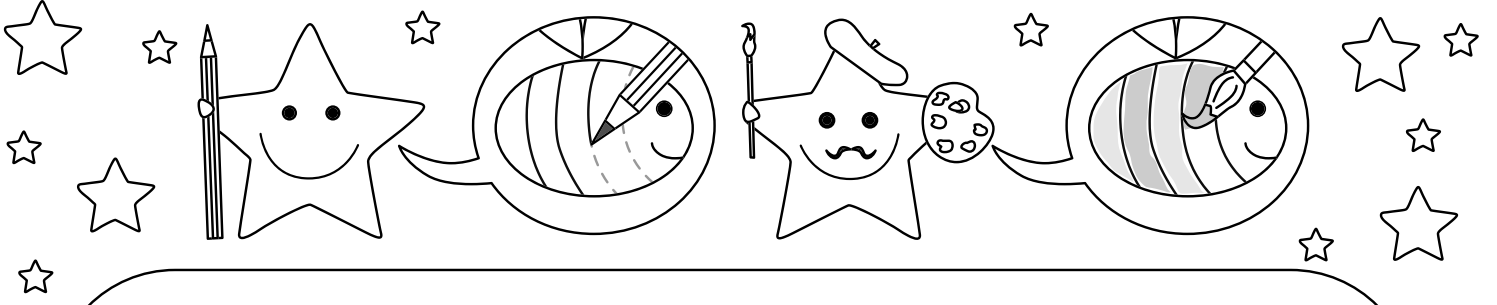

ÇİZGİ ÇALIŞMALARI

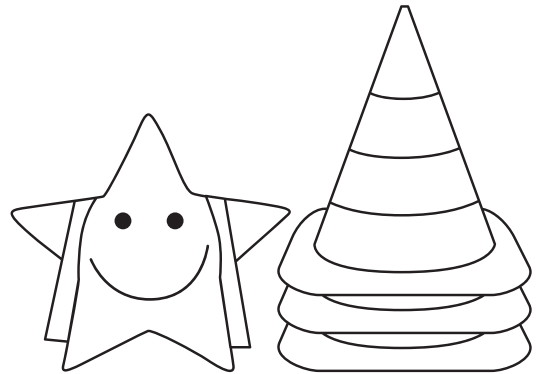
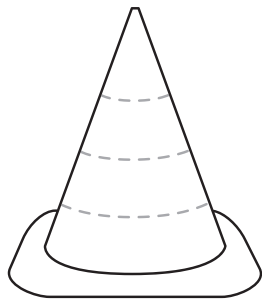
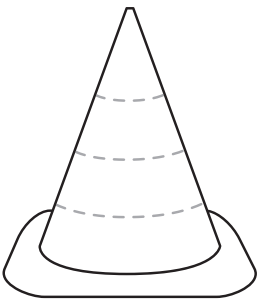
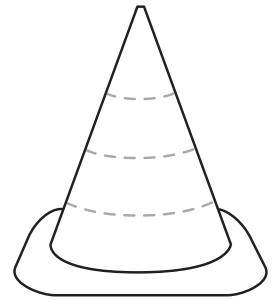
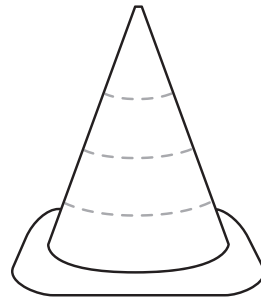
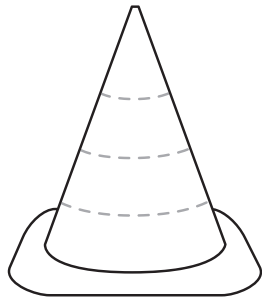
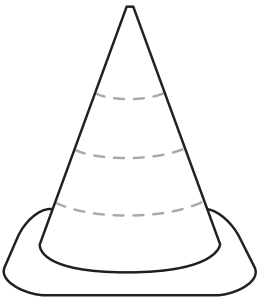
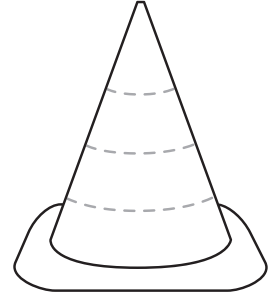
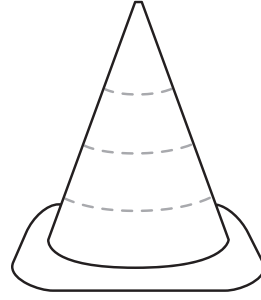
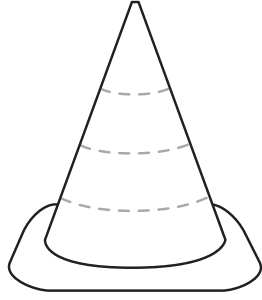
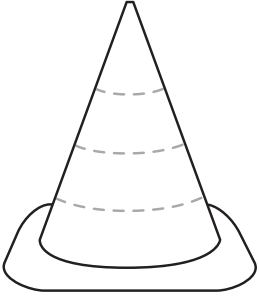
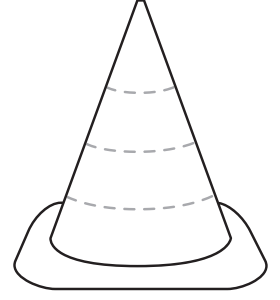
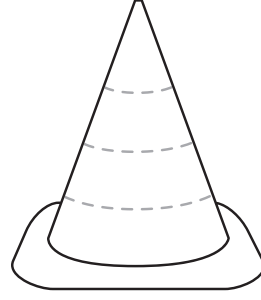
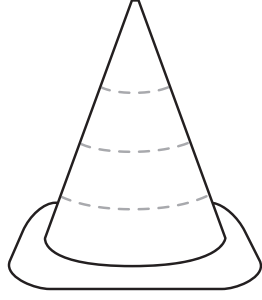
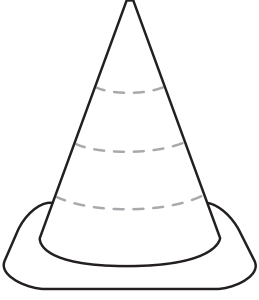
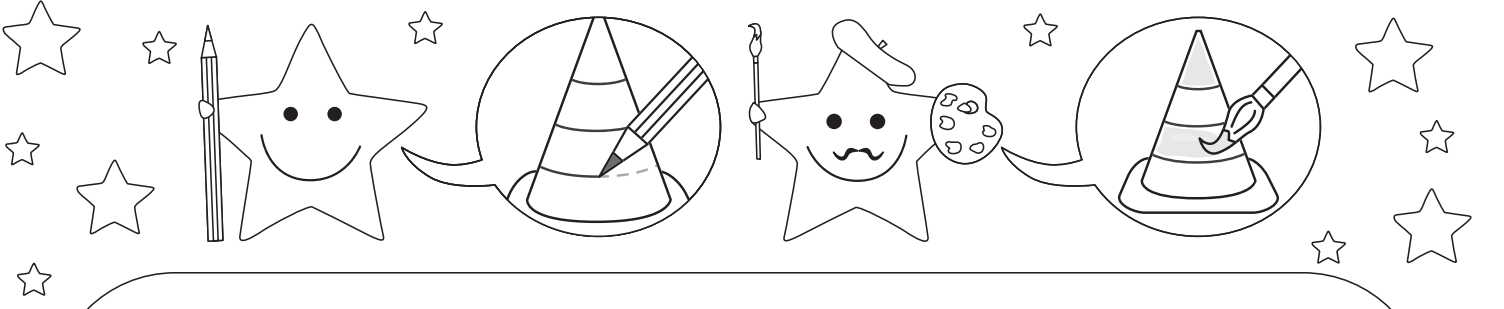

ÇİZGİ ÇALIŞMALARI

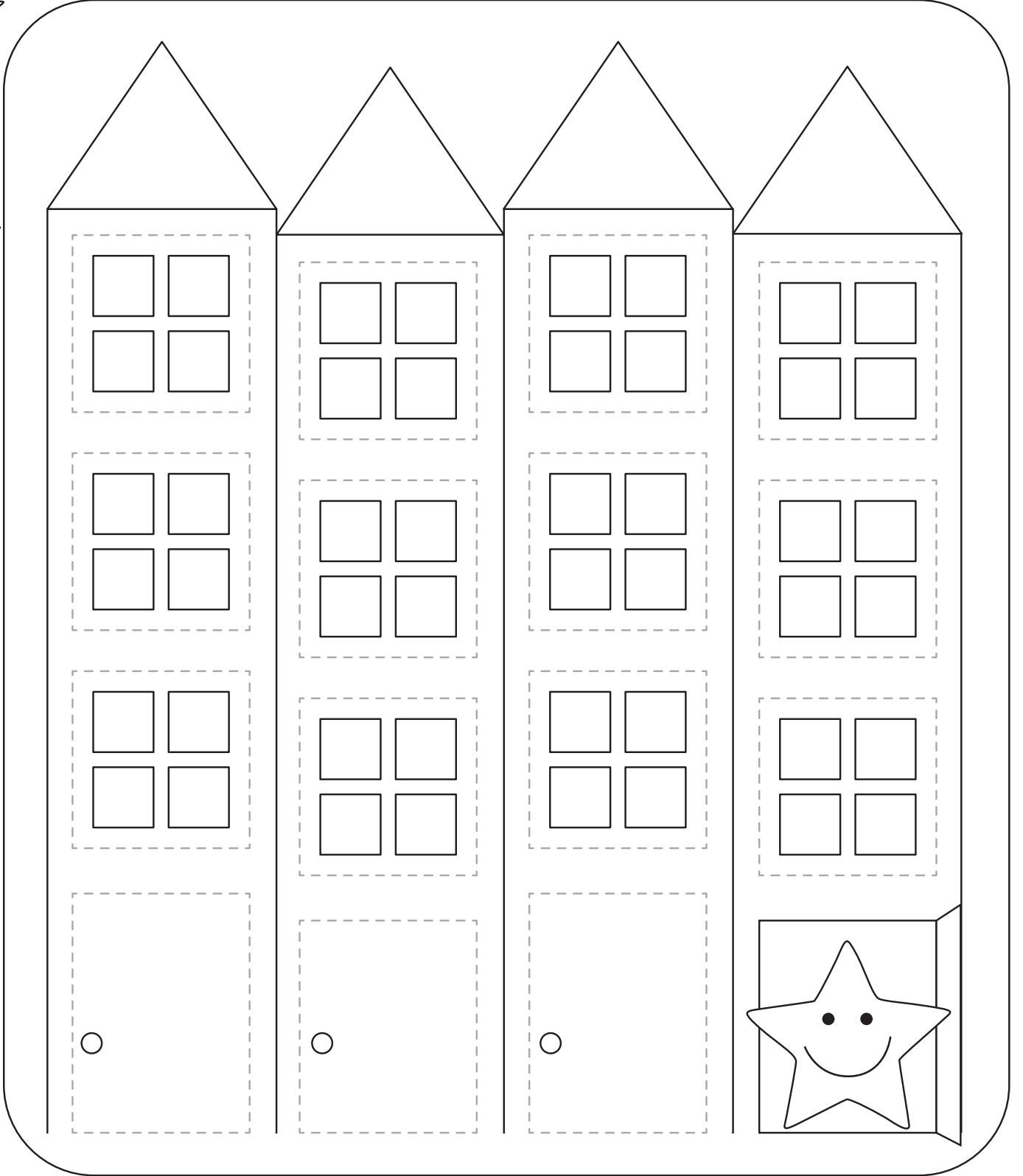
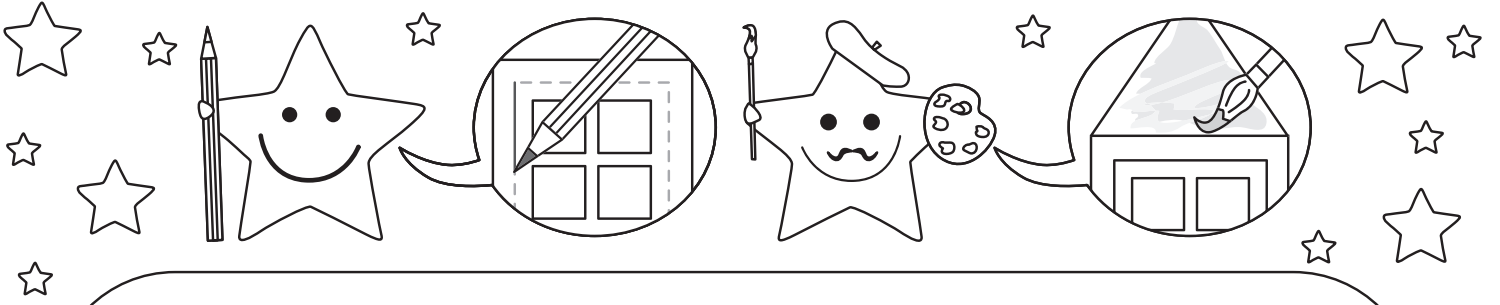

ÇİZGİ ÇALIŞMALARI

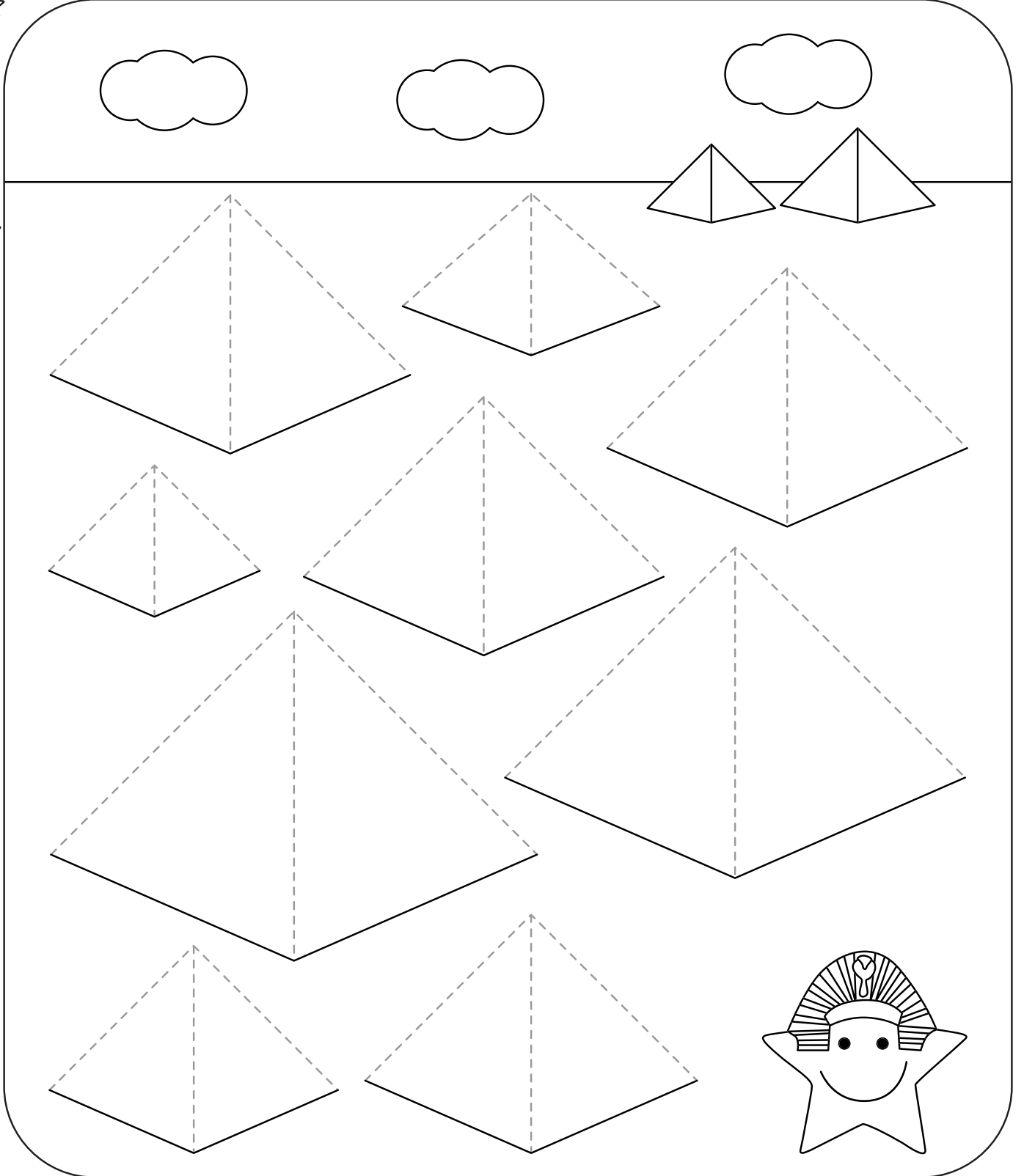
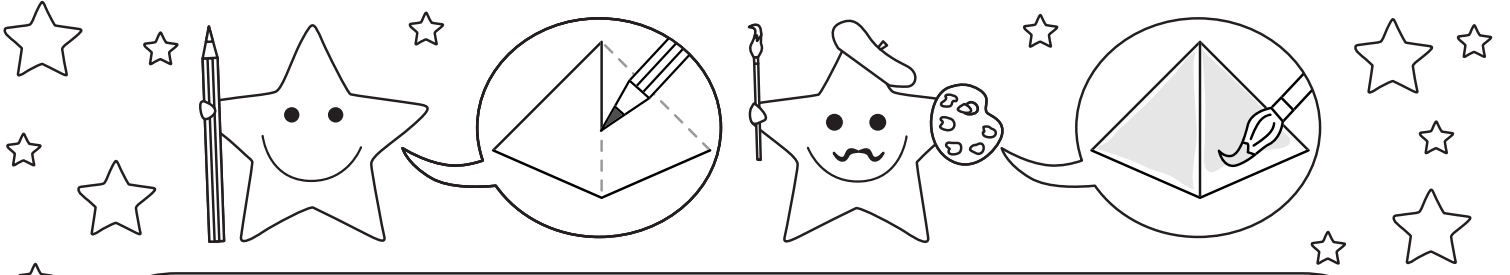

ÇİZGİ ÇALIŞMALARI

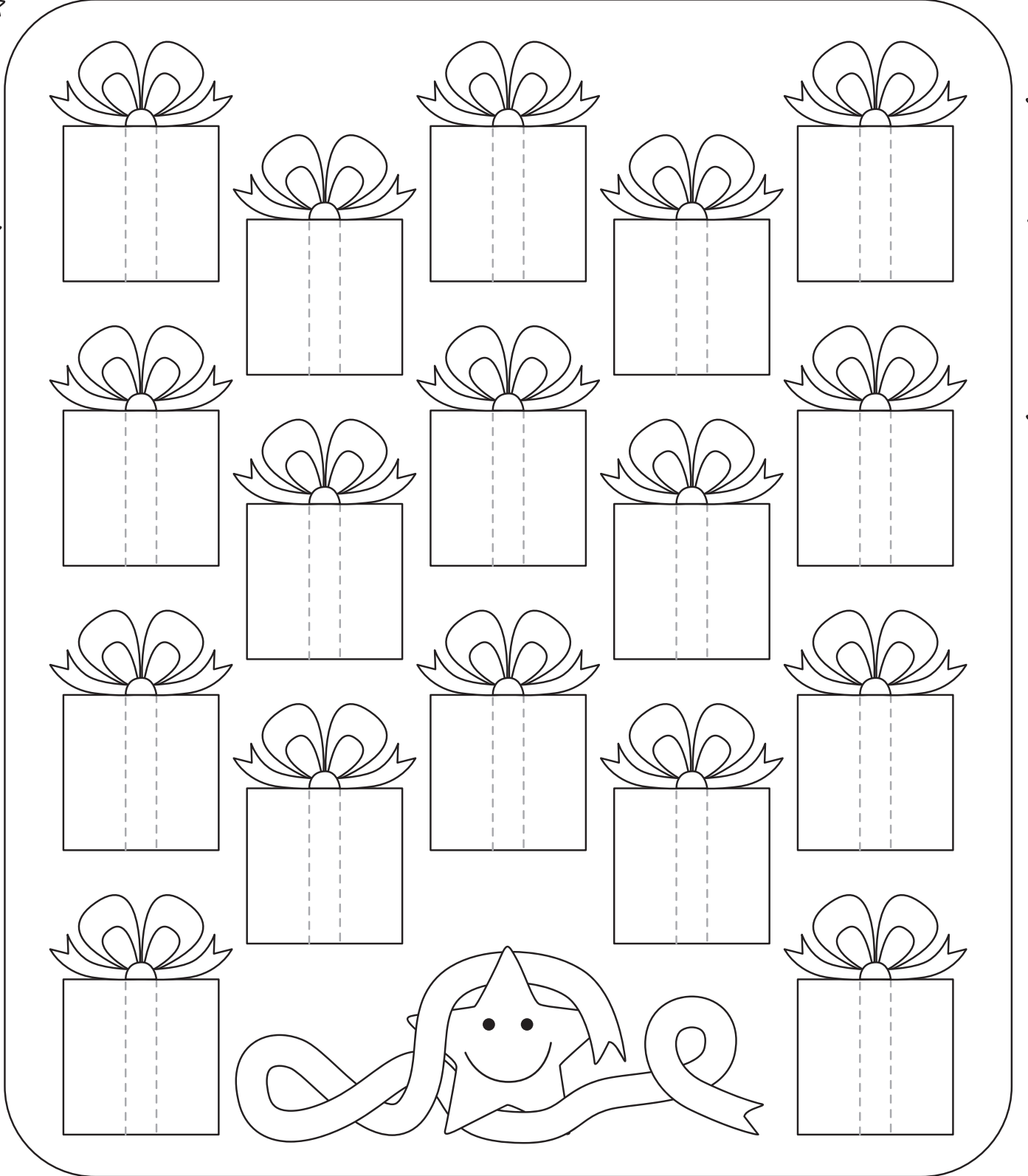
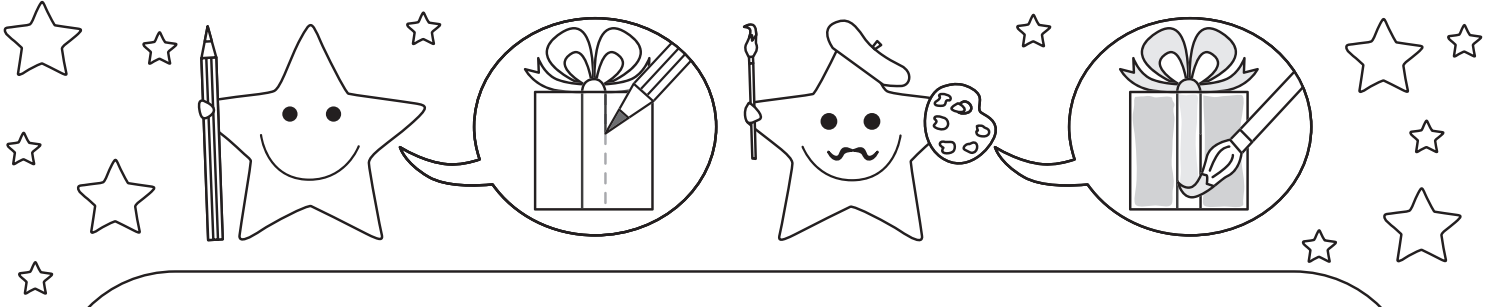

ÇİZGİ ÇALIŞMALARI

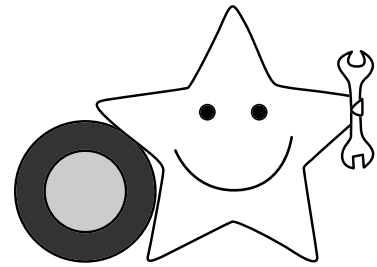
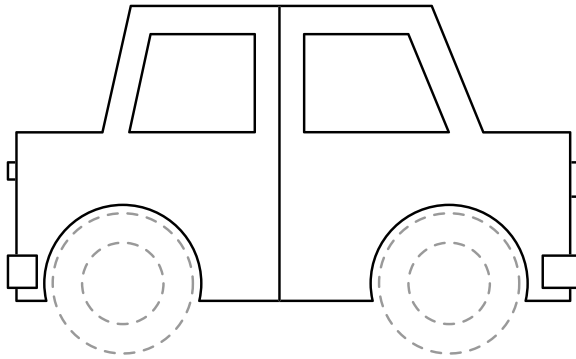
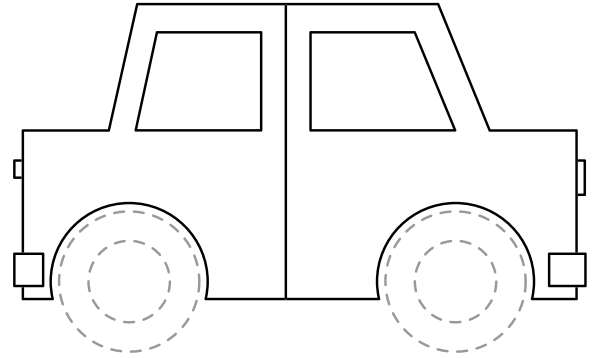
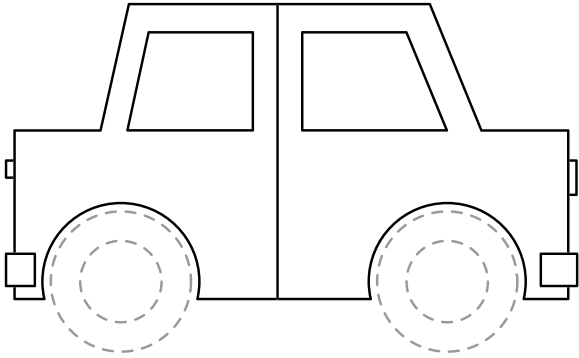
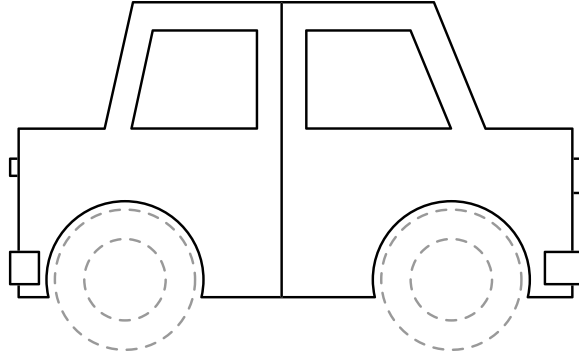
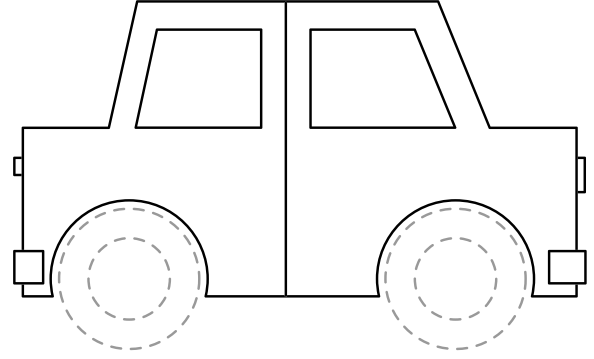
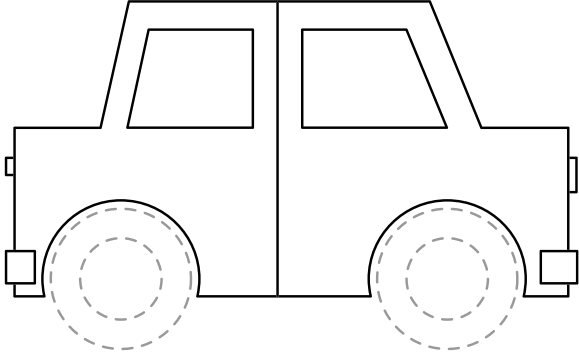
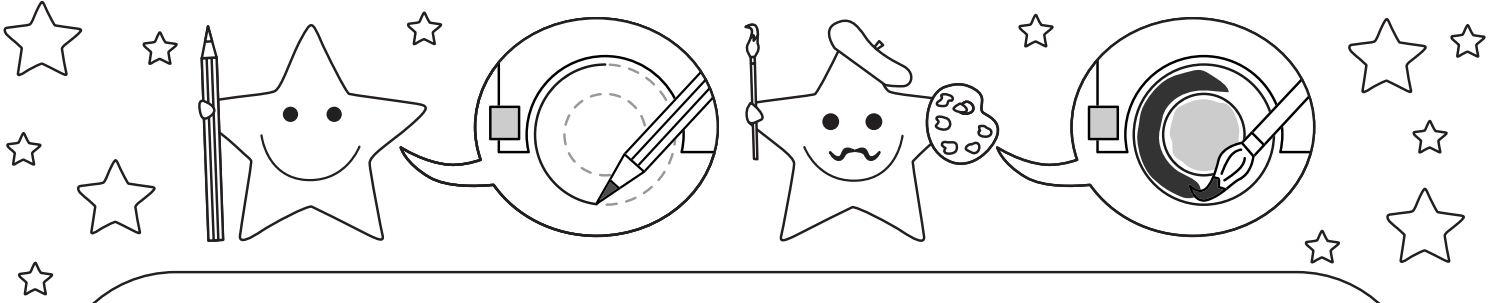

ÇİZGİ ÇALIŞMALARI

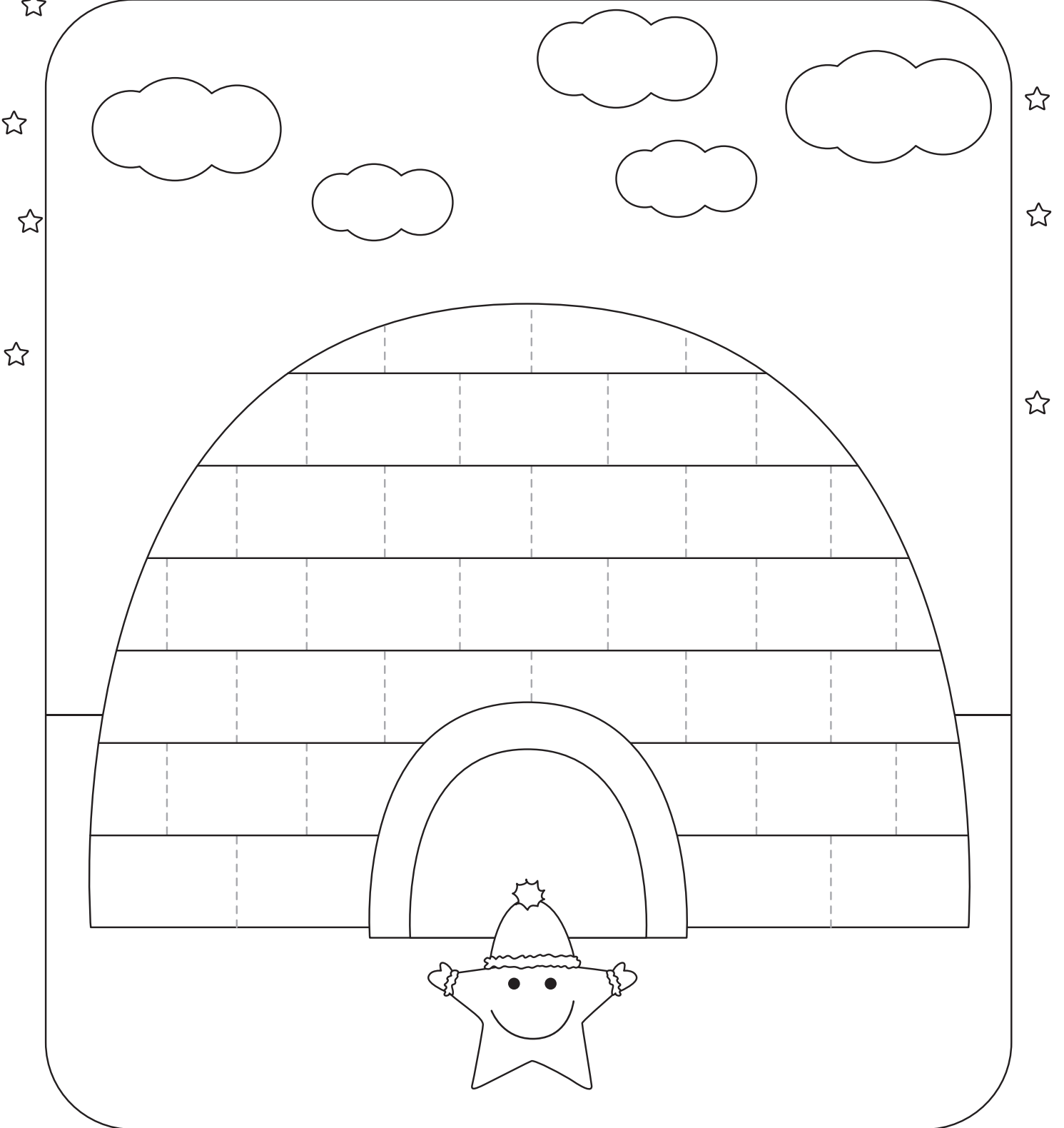
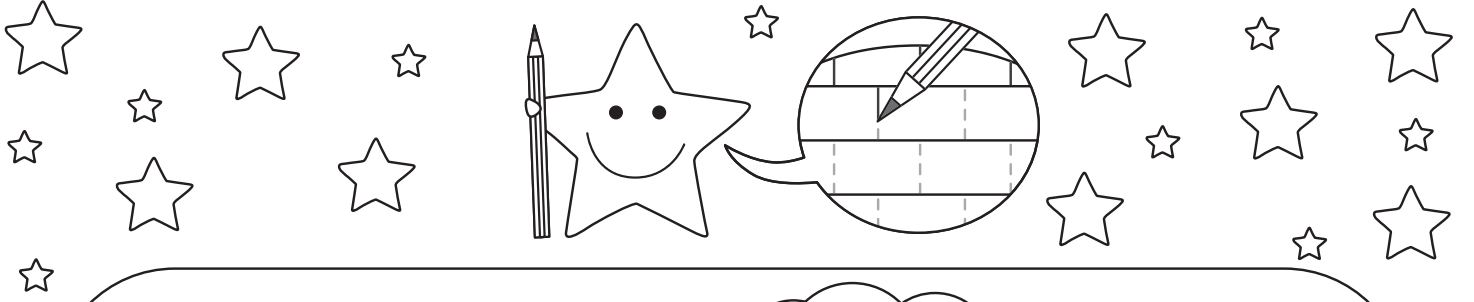

ÇİZGİ ÇALIŞMALARI

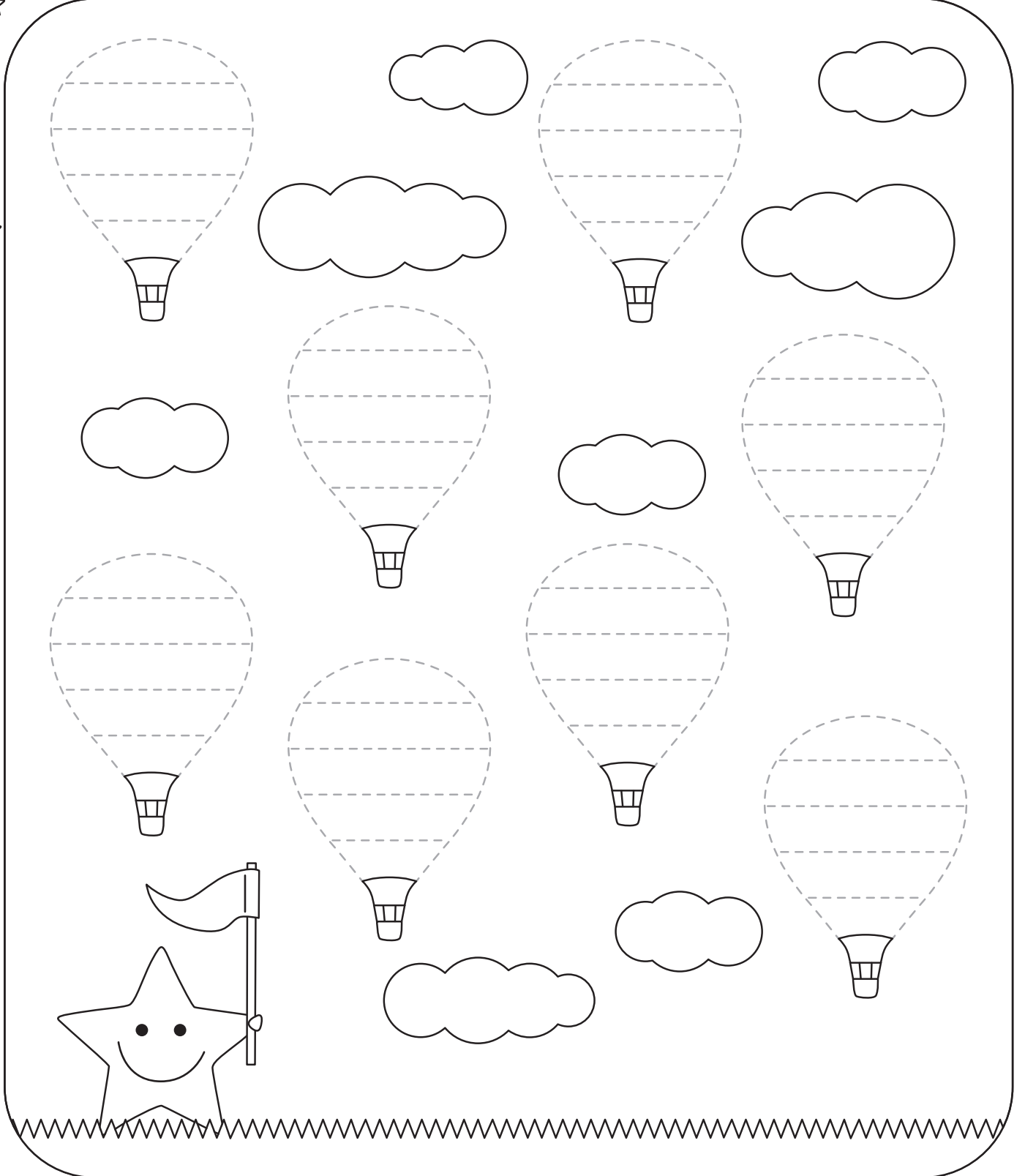
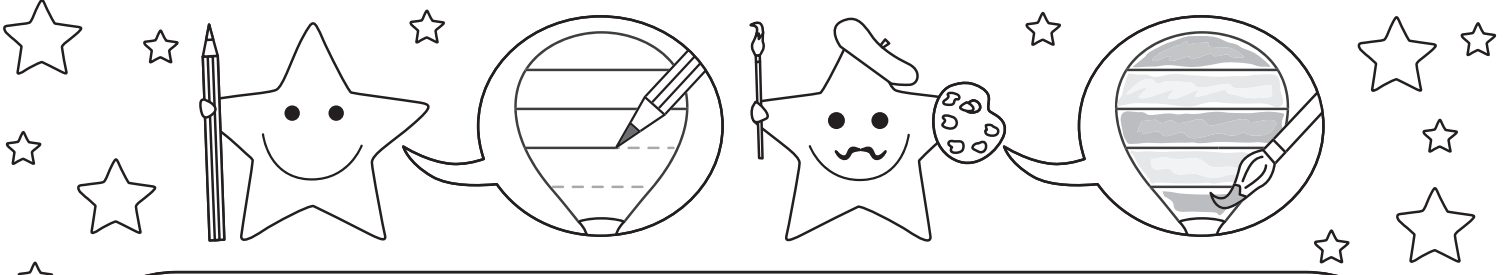

ÇİZGİ ÇALIŞMALARI

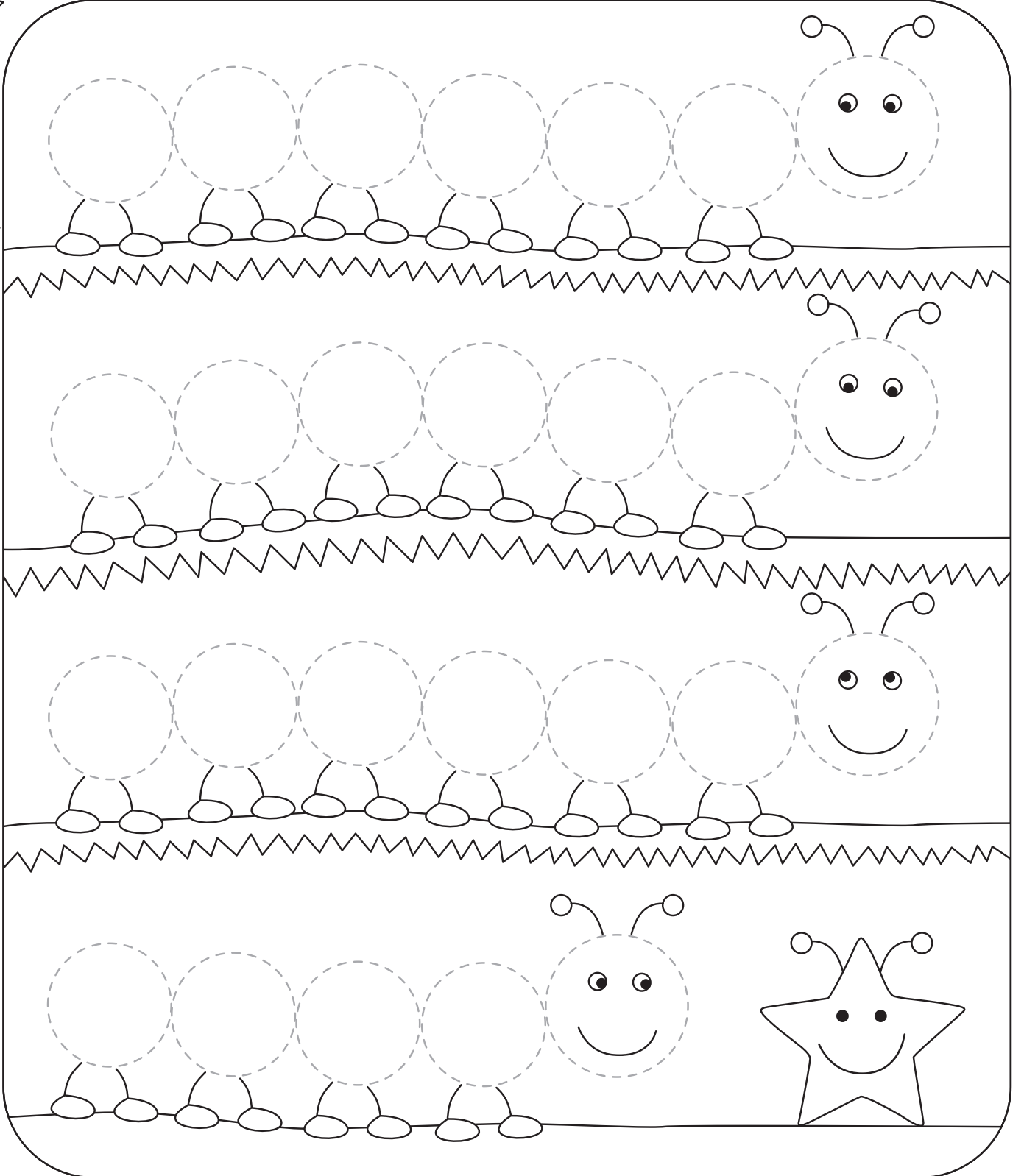
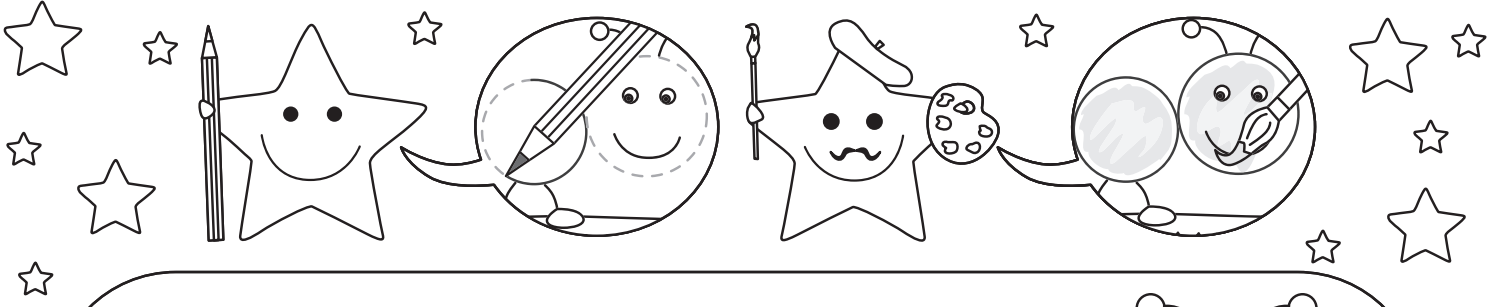

ÇİZGİ ÇALIŞMALARI

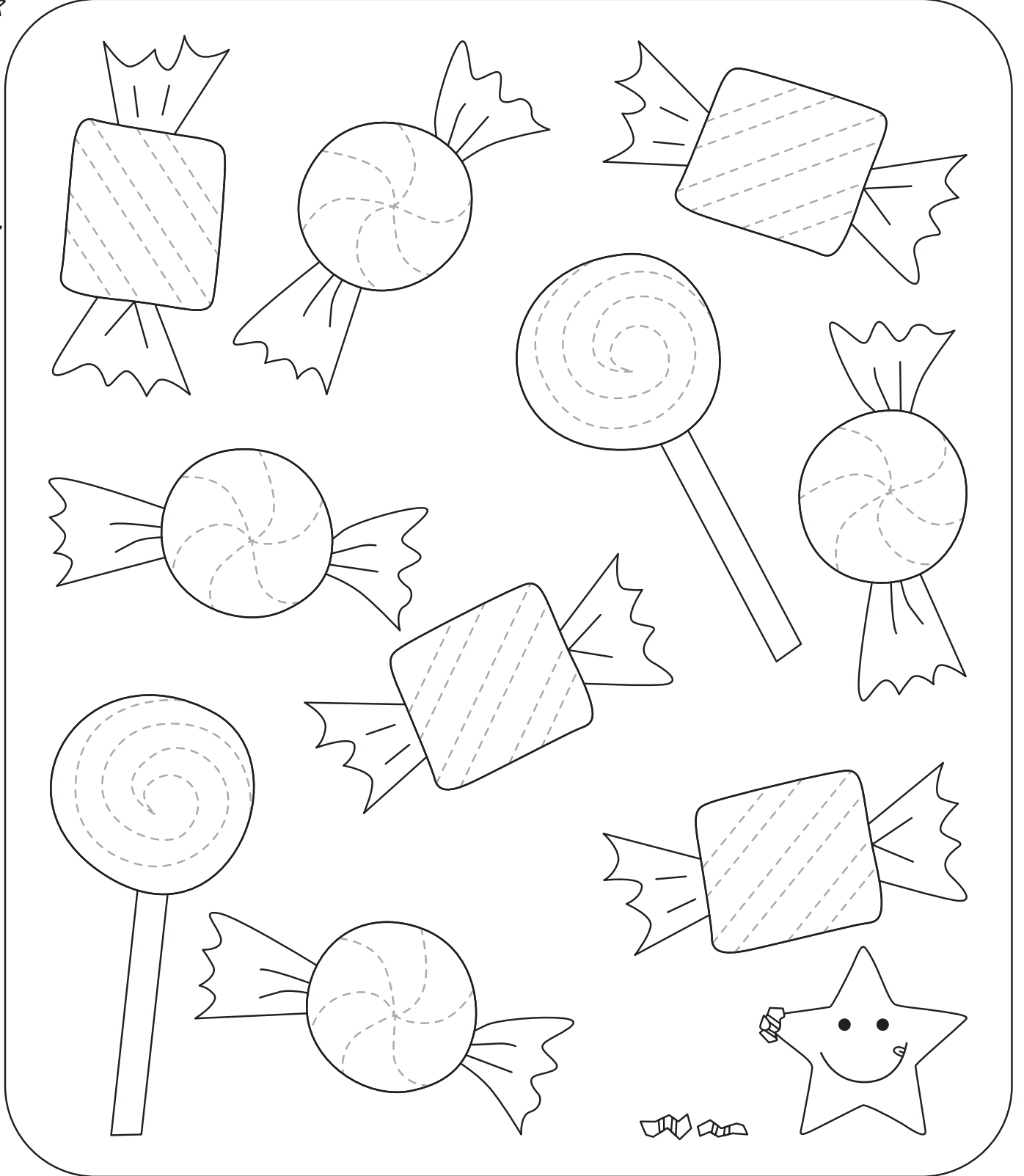
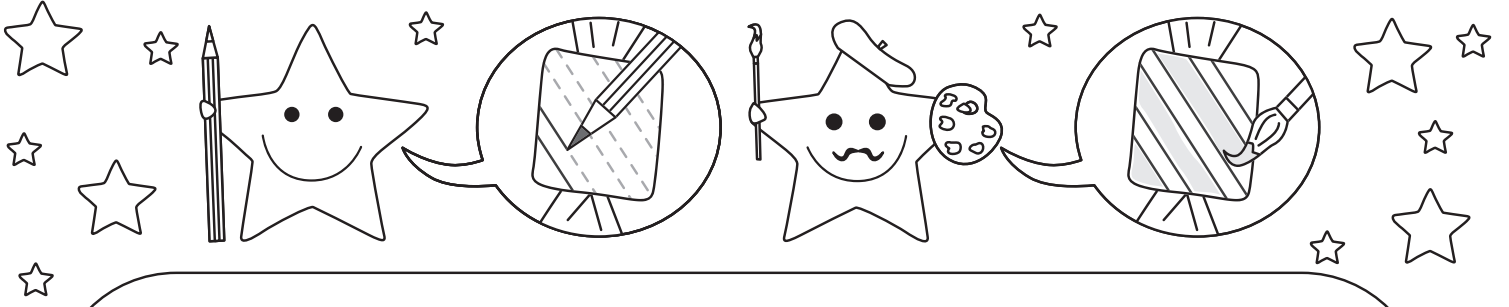

ÇİZGİ ÇALIŞMALARI

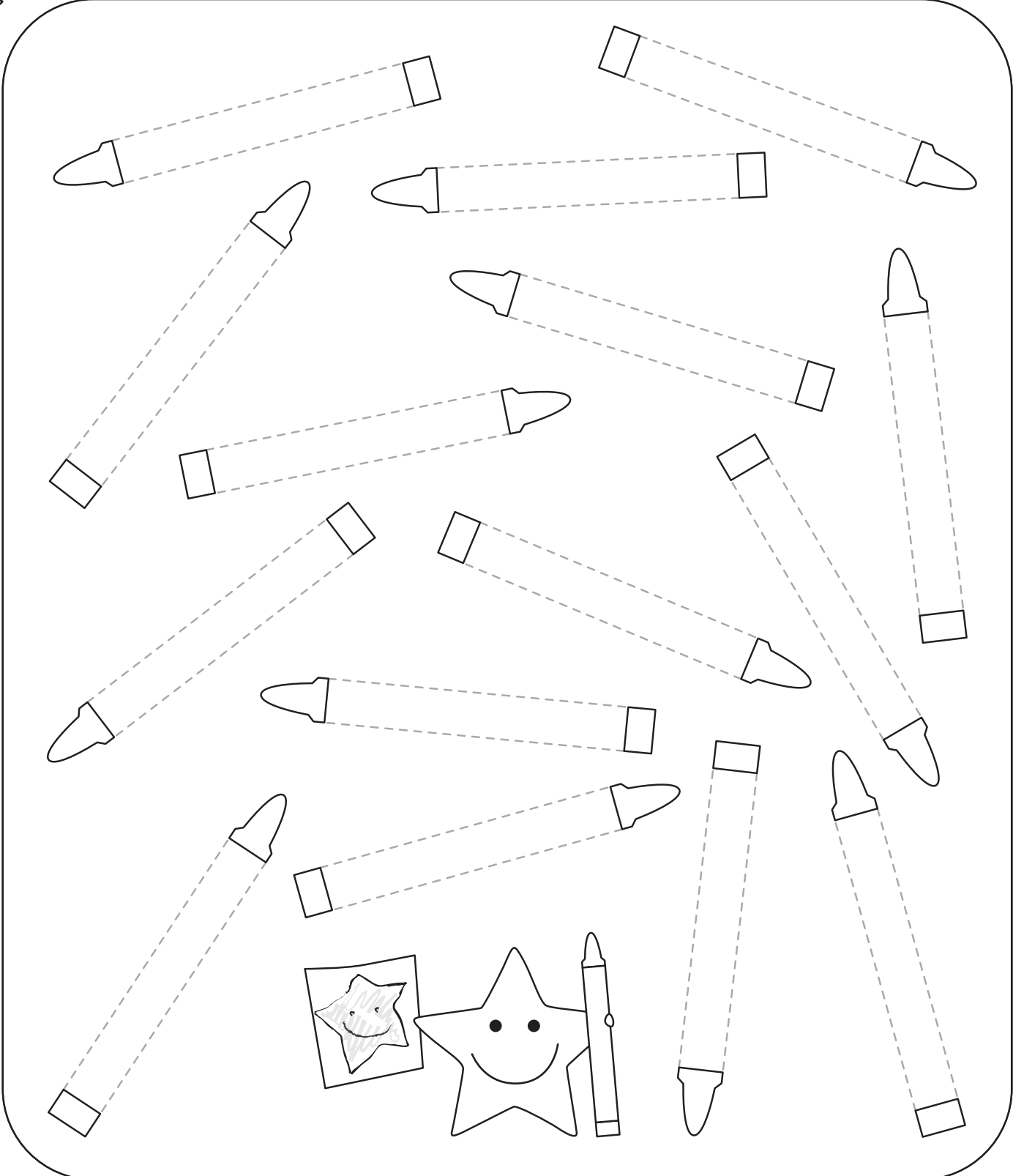
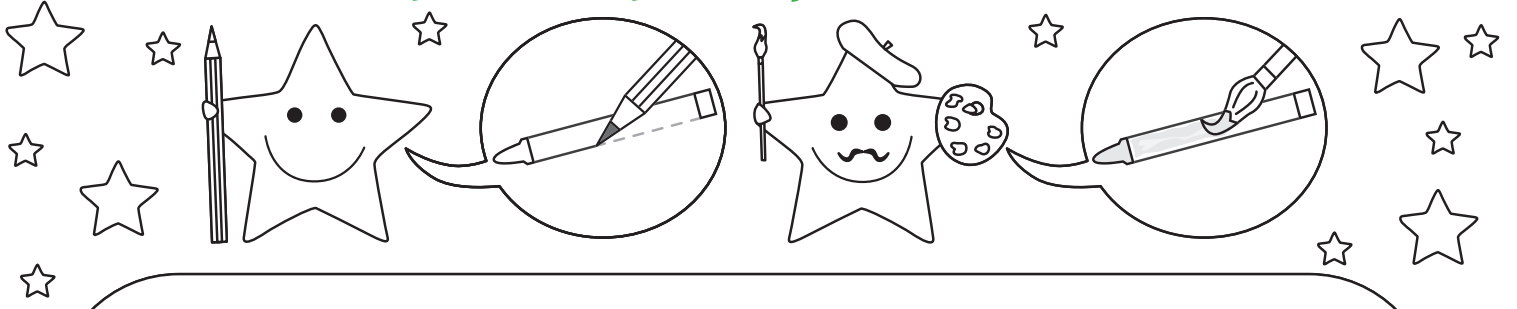

Blank handwriting practice line with a dashed midline.

Blank handwriting practice line with a dashed midline.

Blank handwriting practice line with a dashed midline.

Blank handwriting practice line with a dashed midline.

Blank handwriting practice line with a dashed midline.

Blank handwriting practice line with a dashed midline.

Blank handwriting practice line with a dashed midline.

Blank handwriting practice line with a dashed midline.

Blank handwriting practice line with a dashed midline.

Handwriting practice line with a solid top line, a dashed middle line, and a solid bottom line.

Handwriting practice line with a solid top line, a dashed middle line, and a solid bottom line.

Handwriting practice line with a solid top line, a dashed middle line, and a solid bottom line.

Handwriting practice line with a solid top line, a dashed middle line, and a solid bottom line.

Handwriting practice line with a solid top line, a dashed middle line, and a solid bottom line.

Handwriting practice line with a solid top line, a dashed middle line, and a solid bottom line.

Handwriting practice line with a solid top line, a dashed middle line, and a solid bottom line.

Handwriting practice line with a solid top line, a dashed middle line, and a solid bottom line.

Handwriting practice line with a solid top line, a dashed middle line, and a solid bottom line.